

User Manual

PC Cards cifX

PCI (CIFX 50-XX, CIFX 50-2XX, CIFX 50-2XX\XX)

PCI Express (CIFX 50E-XX)

Low Profile PCI Express (CIFX 70E-XX, CIFX 100EH-RE\CUBE)

Installation, Operation and Hardware Description

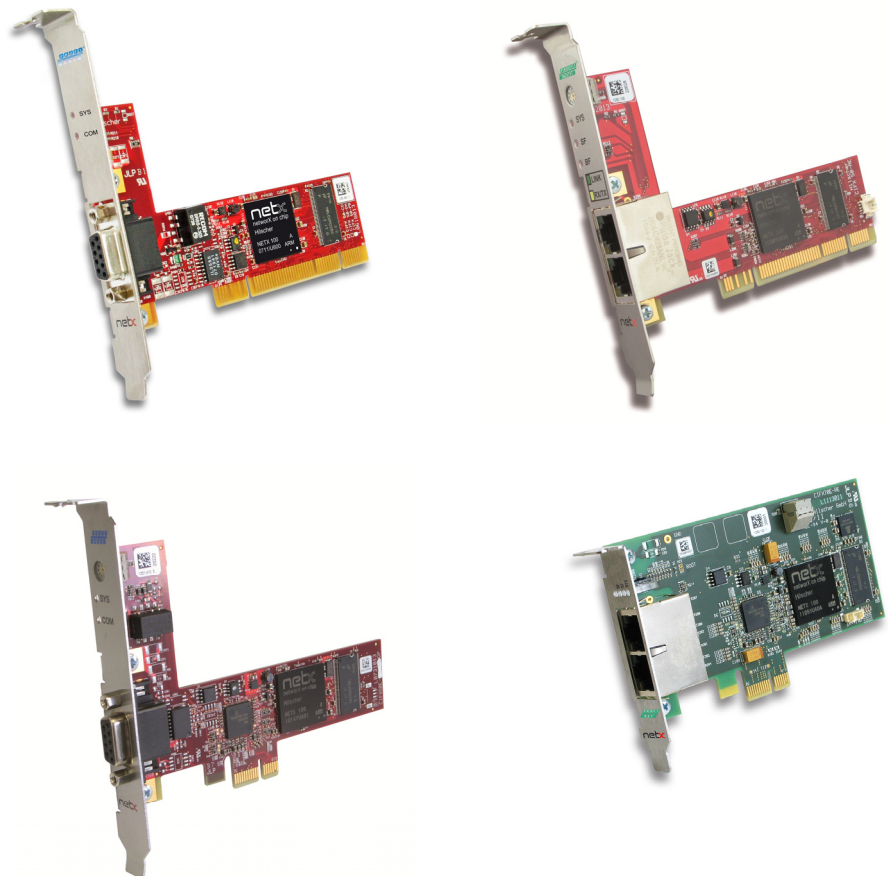

Hilscher Gesellschaft für Systemautomation mbH

www.hilscher.com

DOC120204UM41EN | Revision 41 | English | 2014-07 | Released | Ppublic

Table of Contents

1	INTRODUCTION.....	7
1.1	About the User Manual.....	7
1.1.1	List of Revisions.....	8
1.1.2	Notes on Hardware, Firmware, Software and Driver Versions.....	9
1.1.3	Conventions in this Manual.....	12
1.1.4	Used Terminology.....	12
1.2	Contents of the Product DVD.....	13
1.2.1	Installation Guide, Documentation Overview.....	13
1.2.2	What's New.....	13
1.2.3	Important Changes.....	13
1.2.4	Device Description Files PC Cards cifX.....	16
1.3	Legal Notes.....	17
1.3.1	Copyright.....	17
1.3.2	Important Notes.....	17
1.3.3	Exclusion of Liability.....	18
1.3.4	Warranty.....	18
1.3.5	Export Regulations.....	19
1.3.6	Registered Trademarks.....	19
1.3.7	EtherCAT Disclaimer.....	20
1.3.8	Obligation to read and understand the Manual.....	20
1.4	Licenses.....	20
1.4.1	License Note about VARAN Client.....	20
2	SAFETY.....	21
2.1	General Note.....	21
2.2	Intended Use.....	21
2.3	Personnel Qualification.....	22
2.4	Safety Instructions to avoid Personal Injury.....	22
2.4.1	Electrical Shock Hazard.....	22
2.5	Safety Instructions to avoid Property Damage.....	23
2.5.1	Device Destruction by exceeding allowed Supply Voltage.....	23
2.5.2	Device Destruction by exceeding allowed Signaling Voltage.....	24
2.5.3	Electrostatically sensitive Devices.....	24
2.6	Labeling of Safety Messages.....	25
2.7	References Safety.....	25
3	DESCRIPTIONS AND REQUIREMENTS.....	26
3.1	Description.....	26
3.2	PC Cards PCI CIFX 50-XX.....	26
3.3	PC Cards PCI (2 Channels) CIFX 50-2XX, CIFX 50-2XX\XX.....	27
3.4	PC Cards PCI Express CIFX 50E-XX, CIFX 70E-XX, CIFX 100EH-RE\CUBE.....	27

3.5	The Function „Slot Number (Card ID)“	28
3.6	The Function „DMA Mode“	30
3.7	PC Cards cifX with additional MRAM	31
3.8	System Requirements	32
3.8.1	Slot for the PC Cards cifX PCI, PCIe and Low Profile PCIe	32
3.8.2	Power Supply and Host Interface.....	33
3.8.3	Operating Temperature Range for UL Certificate	33
3.9	Requirements for Operation of the PC Card cifX.....	34
4	GETTING STARTED	35
4.1	Installation and Configuration PC Card cifX	35
4.2	Note on Exchange Service (Replacement Case)	38
4.3	Notes for the Configuration of the Master Device.....	38
4.4	Device Names in SYCON.net.....	40
4.5	Update for Firmware, Driver and Software	42
5	DEVICE DRAWINGS	43
5.1	PC Cards cifX PCI and PCI Express	43
5.1.1	CIFX 50-RE, CIFX 50-RE\ET, CIFX 50E-RE, CIFX 50E-RE\ET	43
5.1.2	CIFX 50-DP, CIFX 50E-DP	45
5.1.3	CIFX 50-2DP	47
5.1.4	CIFX 50-2DP\CO.....	48
5.1.5	CIFX 50-2DP\DN.....	49
5.1.6	CIFX 50-CO, CIFX 50E-CO	50
5.1.7	CIFX 50-2CO.....	52
5.1.8	CIFX 50-2CO\DN.....	53
5.1.9	CIFX 50-DN, CIFX 50E-DN.....	54
5.1.10	CIFX 50-2DN	56
5.1.11	CIFX 50-2ASM, CIFX 50E-2ASM.....	57
5.1.12	CIFX 50-CC, CIFX 50E-CC.....	59
5.2	PC Cards cifX Low Profile PCI Express	61
5.2.1	CIFX 70E-RE, CIFX 70E-RE\MR	61
5.2.2	CIFX 100EH-RE\CUBE	63
5.2.3	CIFX 70E-DP, CIFX 70E-DP\MR	64
5.2.4	CIFX 70E-CO, CIFX 70E-CO\MR	66
5.2.5	CIFX 70E-DN, CIFX 70E-DN\MR.....	68
6	HARDWARE INSTALLATION AND UNINSTALLING	70
6.1	Safety Messages on Personal Injury	70
6.1.1	Electrical Shock Hazard	70
6.2	Property Damage Messages	71
6.2.1	Device Destruction by exceeding allowed Supply Voltage	71
6.2.2	Device Destruction by exceeding allowed Signaling Voltage	71
6.2.3	Electrostatically sensitive Devices.....	71
6.3	Fix Front Plate Sticker	72

6.3.1	Fix Front Plate Sticker at CIFX 50-RE, CIFX 50-RE\ET, CIFX 50E-RE and CIFX 50E-RE\ET	72
6.3.2	Fix Front Plate Sticker at CIFX 70E-RE, CIFX 70E-RE\MR, CIFX 100EH-RE\CUBE.....	73
6.4	Installing PC Card cifX PCI, PCIe, Low Profile PCIe	75
6.5	Uninstalling the PC Card cifX PCI, PCIe, Low Profile PCIe.....	76
7	TROUBLESHOOTING	77
7.1	Instructions for Problem Solving	77
8	LED DESCRIPTIONS	78
8.1	Overview LEDs Real-Time Ethernet Systems	78
8.2	Overview LEDs Fieldbus Systems.....	79
8.3	System LED.....	79
8.4	EtherCAT Master	80
8.5	EtherCAT Slave	81
8.6	EtherNet/IP Scanner (Master)	82
8.7	EtherNet/IP Adapter (Slave)	83
8.8	Open Modbus/TCP	84
8.9	POWERLINK Controlled Node/Slave	85
8.10	PROFINET IO-Controller	86
8.11	PROFINET IO-Device.....	87
8.12	sercos Master	88
8.13	sercos Slave	89
8.14	VARAN Client (Slave).....	90
8.15	PROFIBUS DP Master	91
8.16	PROFIBUS DP Slave	91
8.17	PROFIBUS MPI Device	92
8.18	CANopen Master	93
8.19	CANopen Slave	94
8.20	DeviceNet Master	95
8.21	DeviceNet Slave	96
8.22	AS Interface Master	97
8.23	CC-Link Slave.....	97
9	DEVICE CONNECTIONS AND SWITCHES	98
9.1	Ethernet Interface	98
9.1.1	Ethernet Pin Assignment at the RJ45 Socket	98
9.1.2	Ethernet Connection Data	99
9.1.3	Use of Hubs and Switches	99
9.2	PROFIBUS Interface	100
9.3	CANopen Interface	100

9.4	DeviceNet Interface	101
9.5	AS-Interface Interface	101
9.6	CC-Link Interface	102
9.7	Rotary Switch for Slot Number (Card ID).....	103
9.7.1	Set Slot Number (Card ID)	103
9.7.2	Note for Device Exchange Service (Replacement Case):	103
9.7.3	Rotary Switch Slot Number PC Cards cifX Low Profile.....	104
9.8	SYNC Connector (Pin-Assignment, Hardware/Firmware)	105
9.8.1	Pin Assignment SYNC Connector, X51 (CIFX 50 50E 70E).....	105
9.8.2	Pin Assignment SYNC Connector, J1 (CIFX 100EH)	105
9.8.3	Items on Hardware	106
9.8.4	Items on Firmware.....	106
9.9	Pin Assignment at the PCI Bus.....	107
9.9.1	Overview.....	107
9.9.2	References PCI Specifications.....	107
9.9.3	Pin Assignment for PCI Express Bus CIFX 100EH-RE\CUBE	108
10	TECHNICAL DATA	109
10.1	Technical Data PC Cards cifX	109
10.1.1	CIFX 50-RE, CIFX 50-RE\ET	109
10.1.2	CIFX 50-DP	111
10.1.3	CIFX 50-2DP	112
10.1.4	CIFX 50-2DP\CO.....	113
10.1.5	CIFX 50-2DP\DN.....	115
10.1.6	CIFX 50-CO	117
10.1.7	CIFX 50-2CO	118
10.1.8	CIFX 50-2CO\DN.....	119
10.1.9	CIFX 50-DN	121
10.1.10	CIFX 50-2DN	122
10.1.11	CIFX 50-2ASM	124
10.1.12	CIFX 50-CC	126
10.1.13	CIFX 50E-RE, CIFX 50E-RE\ET	127
10.1.14	CIFX 50E-DP	130
10.1.15	CIFX 50E-CO	131
10.1.16	CIFX 50E-DN.....	133
10.1.17	CIFX 50E-2ASM.....	134
10.1.18	CIFX 50E-CC.....	136
10.1.19	CIFX 70E-RE, CIFX 70E-RE\MR	138
10.1.20	CIFX 100EH-RE\CUBE	140
10.1.21	CIFX 70E-DP, CIFX 70E-DP\MR	142
10.1.22	CIFX 70E-CO, CIFX 70E-CO\MR	143
10.1.23	CIFX 70E-DN, CIFX 70E-DN\MR.....	145
10.2	PCI IDs PC Cards cifX on the PCI Bus.....	147
10.3	Supported PCI-Bus Commands	147
10.4	Technical Data of the Communication Protocols.....	148
10.4.1	EtherCAT Master.....	148
10.4.2	EtherCAT Slave.....	149

10.4.3	EtherNet/IP Scanner (Master)	150
10.4.4	EtherNet/IP Adapter (Slave).....	151
10.4.5	Open Modbus/TCP	152
10.4.6	POWERLINK Controlled Node/Slave.....	152
10.4.7	PROFINET IO-Controller.....	153
10.4.8	PROFINET IO-Device (V3.4)	154
10.4.9	PROFINET IO Device (V3.5).....	155
10.4.10	sercos Master	156
10.4.11	sercos Slave	157
10.4.12	VARAN Client (Slave).....	158
10.4.13	PROFIBUS DP Master	159
10.4.14	PROFIBUS DP Slave	160
10.4.15	PROFIBUS MPI.....	161
10.4.16	CANopen Master	162
10.4.17	CANopen Slave	163
10.4.18	DeviceNet Master	164
10.4.19	DeviceNet Slave	165
10.4.20	AS-Interface Master.....	166
10.4.21	CC Link Slave.....	167
11	ANNEX.....	168
11.1	Matrix Label	168
11.2	EtherCAT Summary over Vendor ID, Conformance test, Membership and Network Logo.....	168
11.2.1	Vendor ID	168
11.2.2	Conformance	169
11.2.3	Certified Product vs. Certified Network Interface	169
11.2.4	Membership and Network Logo	169
11.3	Notes on earlier Hardware Revisions	170
11.3.1	Failure in 10 MBit/s Half Duplex Mode and Workaround	170
11.4	Disposal of Waste Electronic Equipment.....	171
11.5	References	171
11.6	List of Figures	172
11.7	List of Tables	173
11.8	Glossary.....	175
11.9	Contacts.....	184

1 Introduction

1.1 About the User Manual

This user manual provides descriptions of the **installation, operation and hardware** of the PC Cards cifX *PCI, PCI Express* and *Low Profile PCI Express* under Windows® XP, Windows® Vista, Windows® 7 and Windows® 8, as listed subsequently.

PC Cards cifX:

- PCI (CIFX50),
- PCI Express (CIFX 50E),
- Low Profile PCI Express (CIFX 70E, CIFX 100EH-RE\CUBE*)

**only Real-Time Ethernet*

for the Real-Time Ethernet systems:

- EtherCAT
- EtherNet/IP
- Open-Modbus/TCP
- POWERLINK
- PROFINET IO
- sercos
- VARAN

for the fieldbus systems:

- PROFIBUS DP
- PROFIBUS MPI
- CANopen
- DeviceNet
- AS-Interface
- CC-Link



For information about the **Installation of the Software** refer to the User Manual „Software Installation for PC Cards cifX“ [DOC120207UMXXEN].

For information about the **Wiring of the Protocol Interface** refer to the „Wiring Instructions“ [DOC120208UMXXEN].

The **devices described in this manual** are listed in the sections

- *PC Cards PCI CIFX 50-XX* (page 26),
 - *PC Cards PCI (2 Channels) CIFX 50-2XX, CIFX 50-2XX\XX* (page 27) and
 - *PC Cards PCI Express CIFX 50E-XX, CIFX 70E-XX, CIFX 100EH-RE\CUBE* (page 27).
- The devices are described in detail in the chapters *Hardware Installation and Uninstalling* (page 70), *LED Descriptions* (page 78), *Device Connections and Switches* (page 98) and *Technical Data* (page 109).

You can download the latest edition of a manual from the website www.hilscher.com under **Support > Downloads > Manuals** or under **Products** directly with the information about your product.

1.1.1 List of Revisions

Index	Date	Chapter	Revisions
38	13-11-22	All, 1.1.2, 1.2.3, 3.8.2, 5, 8.4, 8.5, 8.9, 8.12, 8.20, 8.21, 10.1.1, 10.4.13	<p>In this manual revision the following new PC cards cifX are described:</p> <p>1.) CIFX 50-RE\ET, CIFX 50E-RE\ET: “ET” = “Enlarged Temperature”, e. g. this cards can be used in an enlarged operating temperature range from -20 °C to +70 °C.</p> <p>2.) CIFX 50-2DP\CO, CIFX 50-2DP\DN, CIFX 50-2CO, CIFX 50-2CO\DN, CIFX 50-2DN: with 2 fieldbus interfaces each.</p> <p>3.) CIFX 70E-RE\MR, CIFX 70E-DP\MR, CIFX 70E-CO\MR, CIFX 70E-DN\MR: with the additional memory module MRAM with 128Kbyte (= 64K words) for storing remanent data (via cifX device driver from V1.1.1.0).</p> <p>Further Updates: - cifX Device Driver, Version 1.2.x.x, CompoNet withdrawn, - Storage temperature range added (for PC cards cifX). - Section <i>Notes on Hardware, Firmware, Software and Driver Versions</i> updated. - Section <i>Important Changes</i> updated: Note “PROFINET IO-Device Firmware Versions 2.1 and 3.4” withdrawn, notes “PROFINET IO-Device Firmware Versions 3.4 and 3.5” and “EtherCAT Slave Firmware Versions 2.5 and 4.2” added. - Section <i>Power Supply and Host Interface</i> updated (recommended current added). - Chapter <i>Device Drawings</i> revised and updated. - LED Descriptions: Sections <i>EtherCAT Master, EtherCAT Slave, POWERLINK Controlled Node/Slave, sercos Master, DeviceNet Master and DeviceNet Slave</i> revised/updated. - Lower limit of the operating temperature range for all PC cards cifX Real-Time-Ethernet updated to 0 °C: Section <i>CIFX 50-RE, CIFX 50-RE\ET</i>, Operating temperature range updated for CIFX 50-RE (0 to +55°C). Note: Due to a plug element from ERNI the lower limit of the operating temperature for all PC cards cifX Real-Time Ethernet is 0 °C. This applies to all hardware revisions of the PC Card cifX Real-Time Ethernet. - Section <i>PROFIBUS DP Master</i> updated.</p>
39	13-12-18	1.1.2.3, 3.5, 3.6, 10.4.2, 10.4.3, 10.4.4, 10.4.9, 10.4.10, 10.4.11, 10.4.17, 11.5	<p>Section <i>Firmware</i> revised/updated. Sections <i>The Function „Slot Number (Card ID)“</i> and <i>The Function „DMA Mode“</i> revised/updated. Section <i>Technical Data EtherCAT Slave</i> updated. Section <i>Technical Data EtherNet/IP Scanner (Master)</i> updated. Section <i>Technical Data EtherNet/IP Adapter (Slave)</i> updated. Section <i>Technical Data PROFINET IO Device (V3.5)</i> added. Section <i>Technical Data sercos Master</i> updated. Section <i>Technical Data sercos Slave</i> updated. Section <i>Technical Data CANopen Slave</i> updated. Section <i>References</i> updated.</p>
40	14-06-18	All 3.8.3 8.13 10.1	<p>Items on <i>Safety Messages</i> updated. Section <i>Operating Temperature Range for UL Certificate</i> added. Sections <i>sercos Slave (LEDs) flashing frequency for Identification, MST losses, Application error and Watchdog error</i> corrected from 4 Hz to 2 Hz. Section <i>Technical Data PC Cards cifX</i>, operating temperature range updated to -20°C to +70°C for the following PC cards cifX: CIFX 50-2DP, CIFX 50-2CO, CIFX 50-2DN, CIFX 50-2DP\CO, CIFX 50-2DP\DN, CIFX 50-2CO\DN, CIFX 50-DP, CIFX 50-CO, CIFX 50-DN. Note: The UL certificate is only valid from -20°C to +55°C.</p>
41	14-07-15	3.9, 4.1, 6.3, 9.6, 10.1.12, 10.1.18, 10.1	<p>Sections <i>Requirements for Operation of the PC Card cifX</i> and <i>Installation and Configuration PC Card cifX</i>: notice added about the required PC settings for PC cards cifX PCI Express (Windows "Link State Power Management" must be shut-off). Section <i>Fix Front Plate Sticker</i> updated. Sections <i>CC-Link Interface, CIFX 50-CC</i> and <i>CIFX 50E-CC</i> updated. Section <i>Technical Data PC Cards cifX</i>: Temperature ranges updated for CIFX 50E-DP, CIFX 50E-CO, CIFX 50E-DN and CIFX 50E-CC.</p>

Table 1: List of Revisions

1.1.2 Notes on Hardware, Firmware, Software and Driver Versions



Note on Software Update: The hardware revisions and the versions for the firmware, the driver or the configuration software listed in this section functionally belong together. For existing hardware installation the firmware, the driver and the configuration software must be updated according to the details listed in this section.

For the software upgrade system overview refer to section *Update for Firmware, Driver and Software* on page 42.

1.1.2.1 Hardware: PC Cards cifX

PC Card cifX	Part No.	Hardware Revision	USB from HW Rev.	„Rotary Switch Slot Number (Card ID)“ from HW Rev.	„DMA Mode“ from HW Rev.
CIFX 50-RE	1250.100	5	-	3	1
CIFX 50-RE\ET	1250.105	1	-	1	1
CIFX 50-DP	1250.410	5	-	5	1
CIFX 50-2DP	1252.410	3	-	3	1
CIFX 50-2DP\CO	1252.470	2	-	2	1
CIFX 50-2DP\DN	1252.480	1	-	1	1
CIFX 50-CO	1250.500	5	-	5	1
CIFX 50-2CO	1252.500	2	-	2	1
CIFX 50-2CO\DN	1252.570	1	-	1	1
CIFX 50-DN	1250.510	5	-	5	1
CIFX 50-2DN	1252.510	2	-	2	1
CIFX 50-2ASM	1252.630	2	-	2	1
CIFX 50-CC	1250.740	2	-	2	1
CIFX 50E-RE	1251.100	5	-	4	4
CIFX 50E-RE\ET	1251.105	1	-	1	1
CIFX 50E-DP	1251.410	6	-	5	5
CIFX 50E-CO	1251.500	5	-	4	4
CIFX 50E-DN	1251.510	5	-	4	4
CIFX 50E-2ASM	1253.630	5	-	2	4
CIFX 50E-CC	1251.740	4	-	3	3
CIFX 70E-RE	1.259.100	1	-	1	1
CIFX 70E-RE\MR	1.259.103	1	-	1	1
CIFX 100EH-RE\CUBE	9016.090	4	-	1	1
CIFX 70E-DP	1.259.410	1	-	1	1
CIFX 70E-DP\MR	1.259.413	1	-	1	1
CIFX 70E-CO	1.259.500	1	-	1	1
CIFX 70E-CO\MR	1.259.503	1	-	1	1
CIFX 70E-DN	1.259.510	1	-	1	1
CIFX 70E-DN\MR	1.259.513	1	-	1	1

Table 2: Reference on Hardware PC Cards cifX

1.1.2.2 Driver and Software

Driver and Software		Version
SYCON.net	SYCONnet netX setup.exe	V1.360.x.x
netX Configuration Tool-Setup	netXConfigurationUtility_Setup.exe	1.0510.x.x
cifX Device Driver	cifX Device Driver Setup.exe	1.2.x.x
Toolkit		1.1.x.x
cifX TCP/IP Server for SYCON.net	cifX TCP Server.exe	V2.1.0.0
US Driver	USB Driver of Windows®	5.1.2600.x

Table 3: Reference on Driver and Software

1.1.2.3 Firmware

The downloadable cifX firmware runs on PC Cards cifX *PCI*, *PCI Express* and *Low Profile PCI Express*. The firmware automatically detects whether it is running on a PC Cards cifX *PCI*, *PCI Express* or *Low Profile PCI Express*.

PC Cards with one Channel:

Protocol	Firmware File	Firmware Version	Minimum Version of the Firmware for USB Support
CANopen Master	CIFXCOM.NXF	2.11.x.x	from 2.5.2.0
CANopen Slave	CIFXCOS.NXF	3.6.x.x	from 2.4.4.0
CC-Link Slave	CIFXCCS.NXF	2.9.x.x	-
DeviceNet Master	CIFXDNM.NXF	2.3.x.x	from 2.2.7.0
DeviceNet Slave	CIFXDNS.NXF	2.3.x.x	from 2.2.7.0
EtherCAT Master	cifxecm.NXF	3.0.x.x	from 2.4.4.0
EtherCAT Slave	cifxECS.NXF	2.5. x.x (V2)	from 2.5.13.0
EtherCAT Slave	cifxECS.NXF	4.2.x.x (V4)	from 2.5.13.0
EtherNet/IP Adapter	cifxEIS.NXF	2.7. x.x	from 2.3.4.1
EtherNet/IP Scanner	cifxEIM.NXF	2.6. x.x	from 2.2.4.1
Open-Modbus/TCP	cifxOMB.NXF	2.5. x.x	from 2.3.2.1
POWERLINK Controlled Node	cifxPLS.NXF	2.1. x.x	from 2.1.22.0
PROFIBUS DP Master	CIFXDPM.NXF	2.6.x.x	from 2.3.22.0
PROFIBUS DP Slave	CIFXDPS.NXF	2.7.x.x	from 2.3.30.0
PROFIBUS MPI-Gerät	CIFXMPI.NXF	2.4.x.x	from 2.4.1.2
PROFINET IO-Controller	cifxPNM.NXF	2.6. x.x	from 2.4.10.0
PROFINET IO-Device	cifxPNS.NXF	3.4.x.x (V3)	from 3.4.9.0
PROFINET IO-Device	cifxPNS.NXF	3.5.x.x (V3)	from 3.4.9.0
sercos Master	cifxS3M.NXF	2.1.x.x	from 2.0.14.0
sercos Slave	cifxS3S.NXF	3.1.x.x	from 3.0.13.0
VARAN-Client	cifxvrs.nxf	1.0.x.x	from 1.0.3.0

Table 4: Reference on Firmware (for 1 Channel Systems)

PC Cards PCI and PCI Express with two Channels:

Protocol Channel 0	Protocol Channel 1	Firmware File	Firmware Version
AS-Interface Master	AS-Interface Master	CIFX2ASM.NXF	2.3.x.x
CANopen Master	CANopen Master	C0204040.NXF	1.0.x.x
CANopen Master	CANopen Slave	C0204050.NXF	1.0.x.x
CANopen Master	DeviceNet Master	C0204060.NXF	1.0.x.x
CANopen Slave	CANopen Slave	C0205050.NXF	1.0.x.x
CANopen Slave	DeviceNet Slave	C0205070.NXF	1.0.x.x
DeviceNet Master	DeviceNet Master	C0206060.NXF	1.0.x.x
DeviceNet Slave	DeviceNet Slave	C0207070.NXF	1.0.x.x
PROFIBUS DP Master	PROFIBUS DP Master	CIFX2DPM.NXF	1.0.x.x (new version counting)
PROFIBUS DP Master	CANopen Master	C0201040.NXF	1.0.x.x
PROFIBUS DP Master	DeviceNet Master	C0201060.NXF	1.0.x.x
PROFIBUS DP Slave	PROFIBUS DP Slave	CIFX2DPS.NXF	1.0.x.x (new version counting)
PROFIBUS DP Slave	CANopen Slave	C0202050.NXF	1.0.x.x
PROFIBUS DP Slave	DeviceNet Slave	C0202070.NXF	1.0.x.x

Table 5: Reference on Firmware (for 2 Channel Systems)

1.1.3 Conventions in this Manual

Notes, operation instructions and results of operation steps are marked as follows:

Notes



Important: <important note you must follow to avoid malfunction>



Note: <general note>



<note, where to find further information>

Operation Instructions

1. <instruction>
2. <instruction>

or

- <instruction>

Results

↻ <result>

Safety Messages

The labeling of safety messages is explained in the chapter *Safety*.

1.1.4 Used Terminology

PC Card cifX	Communication Interfaces of the cifX family of Hilscher based on the netX technology.
CIFX 50-RE	Example for the product name for a PC card cifX Real-Time Ethernet.
CIFX 50-XX	Example (,XX' replaces ,RE', ,DP', CO' or ,DN')



For further terminology to the PC cards cifX, its installation, configuration and operation refer to section *Glossary* on page 175.

1.2 Contents of the Product DVD

On the **Communication Solutions DVD** you will find these installation instructions about the software installation and the necessary configuration software, the documentation, the drivers and software for your PC Card cifX, and additional auxiliary tools.

1.2.1 Installation Guide, Documentation Overview



The installation guide **Software Installation and Documentation Overview** on the Communication Solutions DVD are in the directory *Documentation\0. Installation and Overview*. The installation guide includes:

- An overview on the **Content of the Communication Solutions DVD** (in the section *What is on the Communication Solutions DVD?*)
 - Overviews listing the available **Documentations** for PC cards cifX (in chapter *PC Cards cifX, Software and Documentation*).
-

1.2.2 What's New



All current version information for hardware and software described in this manual are provided in the folder *\Documentation\What's New - Communication Solutions DVD RL XX EN.pdf* on the Communication Solutions DVD.

1.2.3 Important Changes

1.2.3.1 DeviceNet Master - SYCON.net and Firmware

The DeviceNet Master firmware from V2.3.11.0 and the DeviceNet Master DTM from V1.360.x.x support the network scan function. If in the device a firmware version V2.3.10.0 or earlier is used then a firmware update to V2.3.11.0 or higher must be done, in order to use the **network scan** function.

1.2.3.2 PROFINET IO-Device Firmware Versions 3.4 and 3.5

The PROFINET IO Device firmware was revised and completed and is available in version 3.5 since the third quarter 2013.

Use the PROFINET IO Device firmware in version 3.5 for a new installation, when you create or develop your application program for the first time.

If you want to change in an existing system from the PROFINET IO Device firmware version 3.4 to the version 3.5, note the following guidelines:

1. Customize your application program according to the Migration Guide **PROFINET IO Device, Migration from V3.4 to V3.5**.



If you want to change to V3.5, please check in the Migration Guide **PROFINET IO Device, Migration from V3.4 to V3.5** which changes are necessary in the application program in order to use version 3.5.

2. Adjust the configuration of your PROFINET IO Controller device. Use the new GSDML file in the configuration software of the PROFINET IO Controller for this:
GSDML-V2.3-HILSCHER-CIFX RE PNS-20130301.xml
3. Update the PROFINET IO Device firmware in your device to version 3.5.

Note also:

- SYCON.net V1.360.x.x can configure the PROFINET IO Device firmware V3.4 as well as V3.5
- netX Configuration Tool V1.0510.x.x can configure the PROFINET IO Device firmware V3.4 as well as V3.5.
- The development of the PROFINET IO Device firmware V3.4 will not be continued, but this firmware version will be delivered furthermore.

On the Communication Solutions DVD, software and manuals relating to both firmware versions V3.4 and V3.5 are available:

	PROFINET IO-Device V3.4 Directory on the DVD \ File:	PROFINET IO-Device V3.5 Directory on the DVD \ File:
Firmware	<i>Firmware\CIFX\cifxpns.nxf</i>	<i>Firmware\CIFX\PNS V3.5.X\cifxpns.nxf</i>
Header	<i>Examples and API\0. Header\Firmware\PROFINET IO Device V3.4.X</i>	<i>Examples and API\0. Header\Firmware\PROFINET IO Device V3.5.X</i>
GSDML	<i>EDS\PROFINET\V3.4.X\GSDML-V2.3-HILSCHER-CIFX RE PNS-20130225.xml</i>	<i>EDS\PROFINET\V3.5.X\GSDML-V2.3-HILSCHER-CIFX RE PNS-20130301.xml</i>
Protocol API	<i>Documentation\7. Programming Manuals\EN\3. Protocol API\PROFINET IO Device V3.4\PROFINET IO Device Protocol API 13 EN.pdf</i> <i>TCP IP - Packet Interface API 13 EN.pdf</i>	<i>Documentation\7. Programming Manuals\EN\3. Protocol API\PROFINET IO Device V3.5\PROFINET IO Device V3.5 Protocol API 06 EN.pdf</i> <i>PROFINET IO Device - Migration from Version 3.4 to 3.5 MG 03 EN.pdf</i>

Table 6: PROFINET IO-Device Firmware Version 3.4 and 3.5, Header, GSDML and Protocol API Manual

1.2.3.3 EtherCAT Slave Firmware Versions 2.5 and 4.2

The EtherCAT Slave firmware was revised and completed and is available in version 4.2 since the third quarter 2013.

Use the EtherCAT Slave firmware in version 4.2 for a new installation, when you create or develop your application program for the first time.

If you want to change in an existing system from the EtherCAT Slave firmware version 2.5 to the version 4.2, note the following guidelines:

1. Customize your application program according to the Migration Guide **EtherCAT Slave, Migration from V2.5 to V4.2**.



If you want to change to V4.2, please check in the Migration Guide **EtherCAT Slave, Migration from V2.5 to V4.2** which changes are necessary in the application program in order to use version 4.2.

2. Adjust the configuration of your EtherCAT Master device. Use the new XML file in the configuration software of the EtherCAT Master for this: *Hilscher CIFX RE ECS V4.2.X.xml*.
3. Update the EtherCAT Slave firmware in your device to version 4.2.

Note also:

- SYCON.net V1.360.x.x can configure the EtherCAT Slave firmware V2.5 as well as V4.2.10.0 and higher.
- netX Configuration Tool V1.0510.x.x can configure the EtherCAT Slave firmware V2.5 as well as V4.2.
- The development of the EtherCAT Slave firmware V2.5 will not be continued, but this firmware version will be delivered furthermore.

On the Communication Solutions DVD, software and manuals relating to both firmware versions V2.5 and V4.2 are available:

	EtherCAT-Slave V2.5 Directory on the DVD \ File:	EtherCAT-Slave V4.2 Directory on the DVD \ File:
Firmware	<i>Firmware\CIFX\cifxecs.nxf</i>	<i>Firmware\CIFX\ECS V4.X\cifxecs.nxf</i>
Header	<i>Examples and API\0. Header\Firmware\EtherCAT Slave V2.5.X</i>	<i>Examples and API\0. Header\Firmware\EtherCAT Slave V4.2.X</i>
XML	<i>EDS\EtherCAT\Slave\V2.X\Hilscher CIFX RE ECS V2.2.X.xml</i>	<i>EDS\EtherCAT\Slave\V4.X\Hilscher CIFX RE ECS V4.2.X.xml</i>
Protocol API	<i>Documentation\7. Programming Manuals\EN\3. Protocol API\EtherCAT Slave V2\EtherCAT Slave Protocol API 21 EN.pdf</i>	<i>Documentation\7. Programming Manuals\EN\3. Protocol API\EtherCAT Slave V4\EtherCAT Slave V4 Protocol API 03 EN.pdf</i> <i>EtherCAT Slave - Migration from Version 2.5 to 4.2 MG 02 EN.pdf</i> <i>Object Dictionary V3 03 API EN.pdf</i>

Table 7: EtherCAT-Slave Firmware Version 2.5 and 4.2, Header, XML and Protocol API Manual

1.2.4 Device Description Files PC Cards cifX

The Communication Solutions DVD **EDS** directory includes the device description files for the PC Cards cifX. The device description file is required to configure the used Master device. The systems Open Modbus/TCP, AS-Interface, PROFIBUS MPI and VARAN do not use device description files.



PC Cards cifX	System	File Name of the Device Description File
CIFX 50-RE, CIFX 50-RE\ET, CIFX 50E-RE, CIFX 50E-RE\ET, CIFX 70E-RE, CIFX 70E-RE\MR, CIFX 100EH-RE\CUBE	EtherCAT Slave	For the EtherCAT Slave Firmware V2.5: <i>Hilscher cifX RE ECS V2.2.x.xml</i> (or with extension DDF) For the EtherCAT Slave Firmware with V4.2.1.0 the <i>Hilscher CIFX RE ECS V4.2.X.xml</i> is provided.
	 Note! If the XML file <i>Hilscher cifX RE ECS V2.2.x.xml</i> is used/re-installed, the firmware must be used/re-installed at the Version 2.5.x.	
	EtherNet/IP Adapter (Slave)	<i>HILSCHER CIFX-RE EIS V1.1.EDS</i>
	EtherNet/IP Scanner (Master)	<i>HILSCHER CIFX-RE EIM V1.0.eds</i>
	 Note! The description files for the EtherNet/IP Master device is needed, when an additional EtherNet/IP Master device shall communicate to a Hilscher EtherNet/IP Master device via EtherNet/IP.	
	POWERLINK Controlled Node/Slave	<i>00000044_CIFX RE PLS.xdd</i>
	PROFINET IO-Device	For the PROFINET IO Device Firmware V3.4: <i>GSDML-V2.3-HILSCHER-CIFX RE PNS-20130225.xml</i> For the PROFINET IO Device Firmware with V3.5.13.1 the <i>GSDML-V2.3-HILSCHER-CIFX RE PNS-20130301.xml</i> is provided.
	sercos Slave	<i>Hilscher CIFX RE S3S FixCFG FSPIO Default.xml</i> , <i>Hilscher CIFX RE S3S VarCFG FSPDrive.xml</i>
	 Note! If you use a sercos Master which is using SDDML files for configuration, and one of the defaults for vendor code, device ID, input data size or output data size was changed, then you have to export a new updated SDDML file from SYCON.net and import this SDDML file into the configuration software for the sercos Master.	
	CIFX 50-DP, CIFX 50-2DP, CIFX 50E-DP, CIFX 70E-DP, CIFX 70E-DP\MR	PROFIBUS DP Slave
CIFX 50-2DP\CO	PROFIBUS DP Slave CANopen Slave	<i>HIL_0B69.GSD</i> <i>CIFX CO COS.eds</i>
CIFX 50-2DP\DN	PROFIBUS DP Slave DeviceNet Slave	<i>HIL_0B69.GSD</i> <i>CIFX_DN_DNS.EDS</i>
CIFX 50-CO, CIFX 50-2CO, CIFX 50E-CO, CIFX 70E-CO, CIFX 70E-COMR	CANopen Slave	<i>CIFX CO COS.eds</i>
CIFX 50-2CO\DN	CANopen Slave DeviceNet Slave	<i>CIFX CO COS.eds</i> <i>CIFX_DN_DNS.EDS</i>
CIFX 50-DN, CIFX 50-2DN, CIFX 50E-DN, CIFX 70E-DN, CIFX 70E-DN\MR	DeviceNet Slave	<i>CIFX_DN_DNS.EDS</i>
CIFX 50-CC, CIFX 50E-CC	CC-Link Slave	<i>cifx-ccs_1.csp, cifx-ccs_2.csp, cifx-ccs_3.csp, cifx-ccs_4.csp</i> , (for one, two, three or four Remote Device Station), <i>cifx-ccs_io.csp</i> (for one Remote IO Device Station)

Table 8: Device Description Files for PC Cards cifX

1.3 Legal Notes

1.3.1 Copyright

© Hilscher, 2008-2014, Hilscher Gesellschaft für Systemautomation mbH

All rights reserved.

The images, photographs and texts in the accompanying material (user manual, accompanying texts, documentation, etc.) are protected by German and international copyright law as well as international trade and protection provisions. You are not authorized to duplicate these in whole or in part using technical or mechanical methods (printing, photocopying or other methods), to manipulate or transfer using electronic systems without prior written consent. You are not permitted to make changes to copyright notices, markings, trademarks or ownership declarations. The included diagrams do not take the patent situation into account. The company names and product descriptions included in this document may be trademarks or brands of the respective owners and may be trademarked or patented. Any form of further use requires the explicit consent of the respective rights owner.

1.3.2 Important Notes

The user manual, accompanying texts and the documentation were created for the use of the products by qualified experts, however, errors cannot be ruled out. For this reason, no guarantee can be made and neither juristic responsibility for erroneous information nor any liability can be assumed. Descriptions, accompanying texts and documentation included in the user manual do not present a guarantee nor any information about proper use as stipulated in the contract or a warranted feature. It cannot be ruled out that the user manual, the accompanying texts and the documentation do not correspond exactly to the described features, standards or other data of the delivered product. No warranty or guarantee regarding the correctness or accuracy of the information is assumed.

We reserve the right to change our products and their specification as well as related user manuals, accompanying texts and documentation at all times and without advance notice, without obligation to report the change. Changes will be included in future manuals and do not constitute any obligations. There is no entitlement to revisions of delivered documents. The manual delivered with the product applies.

Hilscher Gesellschaft für Systemautomation mbH is not liable under any circumstances for direct, indirect, incidental or follow-on damage or loss of earnings resulting from the use of the information contained in this publication.

1.3.3 Exclusion of Liability

The software was produced and tested with utmost care by Hilscher Gesellschaft für Systemautomation mbH and is made available as is. No warranty can be assumed for the performance and flawlessness of the software for all usage conditions and cases and for the results produced when utilized by the user. Liability for any damages that may result from the use of the hardware or software or related documents, is limited to cases of intent or grossly negligent violation of significant contractual obligations. Indemnity claims for the violation of significant contractual obligations are limited to damages that are foreseeable and typical for this type of contract.

It is strictly prohibited to use the software in the following areas:

- for military purposes or in weapon systems;
- for the design, construction, maintenance or operation of nuclear facilities;
- in air traffic control systems, air traffic or air traffic communication systems;
- in life support systems;
- in systems in which failures in the software could lead to personal injury or injuries leading to death.

We inform you that the software was not developed for use in dangerous environments requiring fail-proof control mechanisms. Use of the software in such an environment occurs at your own risk. No liability is assumed for damages or losses due to unauthorized use.

1.3.4 Warranty

Although the hardware and software was developed with utmost care and tested intensively, Hilscher Gesellschaft für Systemautomation mbH does not guarantee its suitability for any purpose not confirmed in writing. It cannot be guaranteed that the hardware and software will meet your requirements, that the use of the software operates without interruption and that the software is free of errors. No guarantee is made regarding infringements, violations of patents, rights of ownership or the freedom from interference by third parties. No additional guarantees or assurances are made regarding marketability, freedom of defect of title, integration or usability for certain purposes unless they are required in accordance with the law and cannot be limited. Warranty claims are limited to the right to claim rectification.

1.3.5 Export Regulations

The delivered product (including the technical data) is subject to export or import laws as well as the associated regulations of different countries, in particular those of Germany and the USA. The software may not be exported to countries where this is prohibited by the United States Export Administration Act and its additional provisions. You are obligated to comply with the regulations at your personal responsibility. We wish to inform you that you may require permission from state authorities to export, re-export or import the product.

1.3.6 Registered Trademarks

Windows® XP, Windows® Vista, Windows® 7 and Windows® 8 are registered trademarks of Microsoft Corporation.

Linux is a registered trademark of Linus Torvalds.

QNX is a registered trademark of QNX Software Systems, Ltd.

VxWorks is a registered trademark of Wind River Systems, Inc.

IntervalZero RTX™ is a trademark of IntervalZero.

Adobe-Acrobat® is a registered trademark of the Adobe Systems Incorporated.

CANopen® is a registered trademark of CAN in AUTOMATION - International Users and Manufacturers Group e.V (CiA), Nürnberg.

CC-Link is a registered trademark of Mitsubishi Electric Corporation, Tokyo, Japan.

DeviceNet™ and EtherNet/IP™ are trademarks of ODVA (Open DeviceNet Vendor Association, Inc).

EtherCAT® is a registered trademark and a patented technology of Beckhoff Automation GmbH, Verl, Germany, formerly Elektro Beckhoff GmbH.

Modbus is a registered trademark of Schneider Electric.

POWERLINK is a registered trademark of B&R, Bernecker + Rainer Industrie-Elektronik Ges.m.b.H, Eggelsberg, Austria

PROFIBUS® and PROFINET® are registered trademarks of PROFIBUS & PROFINET International (PI), Karlsruhe.

sercos and sercos interface are registered trademarks of sercos international e. V., Suessen, Germany.

PCI™, PCI EXPRESS® and PCIe® are trademarks or registered trademarks of the Peripheral Component Interconnect Special Interest Group (PCI-SIG).

All other mentioned trademarks are property of their respective legal owners.

1.3.7 EtherCAT Disclaimer

EtherCAT® is registered trademark and patented technology, licensed by Beckhoff Automation GmbH, Germany.



To get details and restrictions regarding using the EtherCAT technology refer to the following documents:

- “EtherCAT Marking rules”
- “EtherCAT Conformance Test Policy”
- “EtherCAT Vendor ID Policy”

These documents are available at the ETG homepage www.ethercat.org or directly over info@ethercat.org.

A summary over Vendor ID, Conformance test, Membership and Network Logo can be found within the appendix section of this document under section *EtherCAT Summary over Vendor ID, Conformance test, Membership and Network Logo* on page 168.

1.3.8 Obligation to read and understand the Manual



Important!

- To avoid personal injury and to avoid property damage to your system or to your PC card, you must read and understand all instructions in the manual and all accompanying texts to your PC card, before installing and operating your PC card.
- First read the **Safety Instructions** in the safety chapter.
- Obey to all **Safety Messages** in the manual.
- Keep the product DVD providing the product manuals.

1.4 Licenses

If a PC Card cifX is used as a Slave, neither for the firmware nor for the configuration software SYCON.net a license is required.

Licenses will be required if the PC Card cifX is used with

- a firmware with master functionality*.

* The master license includes the PC Card cifX operating as master and the license for the configuration software SYCON.net for the respective cifX.

1.4.1 License Note about VARAN Client

In order to use the PC Card cifX with VARAN, you need a license which you can acquire at the VNO (VARAN Bus-Nutzerorganisation, Bürmooser Straße 10, A-5112 Lamprechtshausen, info@varan-bus.net) after getting a member of VON.

The license as well as the Vendor ID and the Device ID can be adjusted with the SYCON.net configuration software or with the netX Configuration Tool.

2 Safety

2.1 General Note

The documentation in the form of a user manual, an operating instruction manual or other manual types, as well as the accompanying texts have been created for the use of the products by educated personnel. When using the products, all Safety Messages, Safety Messages, Property Damage Messages and all valid legal regulations have to be obeyed. Technical knowledge is presumed. The user has to assure that all legal regulations are obeyed.

2.2 Intended Use

The PC Cards cifX described in this user manual are PC cards for the Real-Time Ethernet or fieldbus communication. Depending from the loaded firmware, the Real-Time Ethernet or fieldbus systems listed in the following table can be realized using the respective PC Card cifX.

PC Cards cifX	Real-Time Ethernet System	PC Cards cifX	Fieldbus System
CIFX 50-RE, CIFX 50-RE\ET, CIFX 50E-RE, CIFX 50E-RE\ET, CIFX 70E-RE, CIFX 70E-RE\MR, CIFX 100EH-RE\CUBE	EtherCAT Master, EtherCAT Slave	CIFX 50-DP CIFX 50E-DP, CIFX 70E-DP, CIFX 70E-DP\MR	PROFIBUS DP Master, PROFIBUS DP Slave, PROFIBUS MPI Device
	EtherNet/IP Scanner (Master), EtherNet/IP Scanner (Slave)	CIFX 50-2DP	PROFIBUS DP Master, PROFIBUS DP Slave
	Open-Modbus/TCP	CIFX 50-2DP\CO	PROFIBUS DP Master, PROFIBUS DP Slave, CANopen Master, CANopen Slave
	POWERLINK-Controlled-Node/Slave	CIFX-50-2DP\DN	PROFIBUS DP Master, PROFIBUS DP Slave, DeviceNet Master, DeviceNet Slave
	PROFINET IO-Controller (Master), PROFINET IO-Device (Slave)	CIFX 50-CO CIFX 50-2CO CIFX 50E-CO, CIFX 70E-CO, CIFX 70E-CO\MR	CANopen Master, CANopen Slave
	sercos Master, sercos Slave	CIFX 50-2CO\DN	CANopen Master, CANopen Slave DeviceNet Master, DeviceNet Slave
	VARAN-Client (Slave)	CIFX 50-DN CIFX 50-2DN CIFX 50E-DN, CIFX 70E-DN, CIFX 70E-DN\MR	DeviceNet Master, DeviceNet Slave
		CIFX 50-2ASM, CIFX 50E-2ASM	AS-Interface Master
		CIFX 50-CC CIFX 50E-CC	CC-Link Slave

Table 9: PC Cards cifX and the Real-Time Ethernet or Fieldbus Systems realized thereby

2.3 Personnel Qualification

The PC Card cifX must only be installed, configured and removed by qualified personnel. Job-specific technical skills for people professionally working with electricity must be present concerning the following topics:

- Safety and health at work
- Mounting and connecting of electrical equipment
- Measurement and Analysis of electrical functions and systems
- Evaluation of the safety of electrical systems and equipment
- Installing and Configuring IT systems

2.4 Safety Instructions to avoid Personal Injury

To ensure your own personal safety and to avoid personal injury, you necessarily must read, understand and follow the following safety instructions and safety messages in this manual about danger causing personal injury, before you install and operate your PC card cifX.

2.4.1 Electrical Shock Hazard

The danger of a lethal electrical shock caused by parts with more than 50V may occur if you open the PC cabinet to install the PC Card cifX.

- HAZARDOUS VOLTAGE is present inside of the PC or of the connecting device, into which the PC Card cifX is integrated. Strictly obey to all safety rules provided by the device's manufacturer in the documentation!
- First disconnect the power plug of the PC or of the connecting device, before you open the cabinet.
- Make sure, that the power supply is off at the PC or at the connecting device.
- Open the PC cabinet and install or remove the PC Card cifX only after disconnecting power.

An electrical shock is the result of a current flowing through the human body. The resulting effect depends on the intensity and duration of the current and on its path through the body. Currents in the range of approximately $\frac{1}{2}$ mA can cause effects in persons with good health, and indirectly cause injuries resulting from startle responses. Higher currents can cause more direct effects, such as burns, muscle spasms, or ventricular fibrillation.

In dry conditions permanent voltages up to approximately 42.4 V peak or 60 V are not considered as dangerous if the contact area is equivalent to the size of a human hand.

Reference Safety [S2]

2.5 Safety Instructions to avoid Property Damage

To avoid property damage respectively device destruction to the PC card cifX and to your system, you necessarily must read, understand and follow the following safety instructions and safety messages in this manual about danger causing property damage, before you install and operate your PC card.

2.5.1 Device Destruction by exceeding allowed Supply Voltage

To avoid device destruction due to high supply voltage to your PC Card cifX, you must observe the following instructions. These instructions apply to all PC Cards cifX described in this manual.

The PC Card cifX may only be operated with the specified supply voltage. Make sure that the limits of the allowed range for the supply voltage are not exceeded. A supply voltage above the upper limit can cause severe damage to the PC Card cifX! A supply voltage below the lower limit can cause malfunction in the PC Card cifX. The allowed range for the supply voltage is defined by the tolerances specified in this manual.

For the PC cards listed hereafter adhere specifically: The PC Card cifX

- CIFX 50-RE, CIFX 50-RE\ET
- CIFX 50-DP, CIFX 50-2DP, CIFX 50-2DP\CO, CIFX 50-2DP\DN, CIFX 50-CO, CIFX 50-2CO, CIFX 50-2CO\DN, CIFX 50-DN, CIFX 50-2DN, CIFX 50-2ASM, CIFX 50-CC
- CIFX 50E-RE, CIFX 50E-RE\ET
- CIFX 50E-DP, CIFX 50E-CO, CIFX 50E-DN, CIFX 50E-2ASM, CIFX 50E-CC
- CIFX 70E-RE, CIFX 70E-RE\MR, CIFX 100EH-RE\CUBE
- CIFX 70E-DP, CIFX 70E-DP\MR
- CIFX 70E-CO, CIFX 70E-CO\MR
- CIFX 70E-DN, CIFX 70E-DN\MR

may not be powered by a 5V supply voltage! The PC Card cifX may only be powered by a 3.3 V dc $\pm 5\%$ supply voltage.



The data on the mandatory supply voltage for the PC Cards cifX described in this manual you find in section *Power Supply and Host Interface* on page 33. There the required and permitted supply voltage is provided by device type inclusively the permitted tolerance range.

2.5.2 Device Destruction by exceeding allowed Signaling Voltage

To avoid device destruction due to high signal voltage to your PC Card cifX, you must observe the following instructions. These instructions apply to all PC Cards cifX described in this manual.

- All I/O signal pins at the PC Card cifX tolerate only the specified signaling voltage!
- Operating of your PC Card cifX with a signaling voltage other than the specified signaling voltage may lead to severe damage to the PC Card cifX!



The data on the mandatory signaling voltage for the PC Cards cifX described in this manual you find in the section *Power Supply and Host Interface* on page 33. There the required and permitted signaling voltage is provided by device type.

2.5.3 Electrostatically sensitive Devices

This equipment is sensitive to electrostatic discharge, which cause internal damage and affect normal operation. Therefore adhere to the necessary safety precautions for components that are vulnerable with electrostatic discharge if you install or replace your device. Follow the guidelines listed hereafter when you handle this equipment:

- Touch a grounded object to discharge potential static.
- Wear an approved grounding wriststrap.
- Do not touch connectors or pins on the PC Card cifX.
- Do not touch circuit components inside the equipment.
- If available, use a static-safe workstation.
- When not in use, store the equipment in appropriate static-safe packaging.

Reference Safety [S3]

2.6 Labeling of Safety Messages

- The **Section Safety Messages** at the beginning of a chapter are pinpointed particularly and highlighted by a signal word according to the degree of endangerment. The kind of danger is specified exactly by the safety message text and *optionally* by a specific safety sign.
- The **Integrated Safety Messages** within an instruction description are highlighted with a signal word according to the degree of endangerment. The kind of danger is specified exactly by the safety message text.







Signal Word	Meaning (international)	Meaning (USA)
	Indicates a direct hazard with high risk, which will have as consequence death or grievous bodily harm if it isn't avoided.	Indicates a Hazardous Situation Which if not Avoided, will Result in Death or Serious Injury.
	Indicates a possible hazard with medium risk, which will have as consequence death or (grievous) bodily harm if it isn't avoided.	Indicates a Hazardous Situation Which if not Avoided, could Result in Death or Serious Injury.
	Indicates a minor hazard with medium risk, which could have as consequence simple battery if it isn't avoided.	Indicates a Hazardous Situation Which if not Avoided, may Result in Minor or Moderate Injury.
Safety Sign	USA	Sort of Warning or Principle
		Warning of Lethal Electrical Shock
		Principle: Disconnect the Power Plug

Table 10: Signal Words and Safety Signa in Safety Messages on Personal Injury



Signal Word	Meaning (international and USA)
	Indicates a Property Damage Message.
Safety Sign	Sort of Warning or Principle
	Warning on Damages by Electrostatic Discharge
-	Example: Warning on Device Destruction due by too high supply voltage

Table 11: Signal Words and Safety Signa in Safety Messages on Property Damage

In this document all Safety Instructions and Safety Messages are designed according both to the international used safety conventions as well as to the ANSI Z535.6 standard, refer to reference safety [S1].

2.7 References Safety

- [S1] ANSI Z535.6-2006 American National Standard for Product Safety Information in Product Manuals, Instructions, and Other Collateral Materials
- [S2] IEC 60950-1, Information technology equipment - Safety - Part 1: General requirements, (IEC 60950-1:2005, modified); German Edition EN 60950-1:2006
- [S3] EN 61340-5-1 and EN 61340-5-2 as well as IEC 61340-5-1 and IEC 61340-5-2

3 Descriptions and Requirements

3.1 Description

The PC Cards cifX are communication interfaces of the cifX product family of Hilscher on the basis of the communication controller netX 100 for the Real-Time Ethernet or fieldbus communication. Depending of the loaded firmware, the protocol specific PC Card cifX proceeds the communication of the corresponding Real-Time Ethernet or fieldbus system.

The used Real-Time Ethernet systems are: The used fieldbus systems are:

- | | |
|--|--|
| <ul style="list-style-type: none"> ▪ EtherCAT Master ▪ EtherCAT Slave ▪ EtherNet/IP Scanner (Master) ▪ EtherNet/IP Adapter (Slave) ▪ Open-Modbus/TCP ▪ POWERLINK-Controlled-Node/Slave ▪ PROFINET IO-Controller (Master) ▪ PROFINET IO-Device (Slave) ▪ sercos Master ▪ sercos Slave ▪ VARAN Client (Slave) | <ul style="list-style-type: none"> ▪ PROFIBUS DP Master ▪ PROFIBUS DP Slave ▪ PROFIBUS MPI Device ▪ CANopen Master ▪ CANopen Slave ▪ DeviceNet Master ▪ DeviceNet Slave ▪ AS-Interface Master ▪ CC-Link Slave |
|--|--|

The PC Card cifX handles the complete data exchange between the connected Ethernet or fieldbus devices and the PC. The data exchange is proceeded via dual-port memory.

3.2 PC Cards PCI CIFX 50-XX

PC Card cifX	Description
PC Cards PCI with integrated Ethernet or fieldbus interface	
Real-Time Ethernet	
CIFX 50-RE bzw. CIFX 50-RE\ET	PC Card cifX PCI for Real-Time Ethernet Master or Slave Note: The PC card CIFX 50-RE\ET can be used in an enlarged temperature rage from -20 °C to +70 °C.
PROFIBUS	
CIFX 50-DP	PC Card cifX PCI PROFIBUS DP Master or Slave and PROFIBUS MPI Device
CANopen	
CIFX 50-CO	PC Card cifX PCI CANopen Master or Slave
DeviceNet	
CIFX 50-DN	PC Card cifX PCI DeviceNet Master or Slave
CC-Link	
CIFX 50-CC	PC Card cifX PCI CC-Link Slave

Table 12: PC Cards PCI CIFX 50-XX

3.3 PC Cards PCI (2 Channels) CIFX 50-2XX, CIFX 50-2XX\XX

PC Card cifX	Description
PC Cards PCI with 2 integrated fieldbus interfaces (2 Channels)	
PROFIBUS	
CIFX 50-2DP	PC Card cifX PCI 2 channel PROFIBUS DP Master or Slave
CIFX 50-2DP\CO	PC Card cifX PCI 2 channel - channel X0 PROFIBUS DP Master or Slave, channel X1 CANopen Master or Slave
CIFX 50-2DP\DN	PC Card cifX PCI 2 channel - channel X0 PROFIBUS DP Master or Slave, channel X1 DeviceNet Master or Slave
CANopen	
CIFX 50-2CO	PC Card cifX PCI 2 channel CANopen Master or Slave
CIFX 50-2CO\DN	PC Card cifX PCI 2 channel - channel X0 CANopen Master or Slave, channel X1 DeviceNet Master or Slave
DeviceNet	
CIFX 50-2DN	PC Card cifX PCI 2 channel DeviceNet Master or Slave
AS-Interface	
CIFX 50-2ASM	PC Card cifX PCI 2 channel AS-Interface Master
CIFX 50E-2ASM	PC Card cifX PCI Express 2 channel AS-Interface Master

Table 13: PC Cards PCI (2 Channels) CIFX 50-2XX, CIFX 50-2XX\XX

3.4 PC Cards PCI Express CIFX 50E-XX, CIFX 70E-XX, CIFX 100EH-RE\CUBE

PC Card cifX	Description
PC Cards PCI Express with integrated Ethernet or fieldbus interface	
Real-Time Ethernet	
CIFX 50E-RE bzw. CIFX 50E-RE\ET	PC Card cifX PCI Express for Real-Time Ethernet Master or Slave Note: The PC card CIFX 50E-RE\ET can be used in an enlarged temperature range from -20°C to +70 °C.
CIFX 70E-RE or CIFX 70E-RE\MR	PC Card cifX Low Profile PCI Express Real-Time-Ethernet Master or Slave (Low Profile PCIe with RTE) Note: The PC card CIFX 70E-RE\MR additionally is equipped with an MRAM (128Kbyte = 64K Words). For further information refer to section <i>PC Cards cifX with additional MRAM</i> on page 31.
CIFX 100EH-RE\CUBE	PC Card cifX PCI Express for Real-Time Ethernet Master or Slave, (low-profile card) exclusively for the installing in KEBA KeControl industry PCs series CP 3XX (Cube).
PROFIBUS	
CIFX 50E-DP	PC Card cifX PCI Express PROFIBUS DP Master or Slave and PROFIBUS MPI Device
CIFX 70E-DP or CIFX 70E-DP\MR	PC Card cifX Low Profile PCI Express PROFIBUS DP Master or Slave and PROFIBUS MPI Device (Low Profile PCIe with PROFIBUS) Note: The PC card CIFX 70E-DP\MR additionally is equipped with an MRAM (128Kbyte = 64K Words). For further information refer to section <i>PC Cards cifX with additional MRAM</i> on page 31.
CANopen	
CIFX 50E-CO	PC Card cifX PCI Express CANopen Master or Slave
CIFX 70E-CO or CIFX 70E-CO\MR	PC Card cifX Low Profile PCI Express CANopen Master or Slave (Low Profile PCIe with CANopen) Note: The PC card CIFX 70E-CO\MR additionally is equipped with an MRAM (128Kbyte = 64K Words). For further information refer to section <i>PC Cards cifX with additional MRAM</i> on page 31.
DeviceNet	
CIFX 50E-DN	PC Card cifX PCI Express DeviceNet Master or Slave

PC Card cifX	Description
CIFX 70E-DN or CIFX 70E-DNMR	PC Card cifX Low Profile PCI Express DeviceNet Master or Slave (Low Profile PCIe with DeviceNet) Note: The PC card CIFX 70E-DNMR additionally is equipped with an MRAM (128Kbyte = 64K Words). For further information refer to section <i>PC Cards cifX with additional MRAM</i> on page 31.
CC-Link	
CIFX 50E-CC	PC Card cifX PCI Express CC-Link Slave

Table 14: PC Cards PCI Express CIFX 50E-XX, CIFX 70E-XX

3.5 The Function „Slot Number (Card ID)“

Device revisions equipped with a **Rotary Switch Slot Number (Card ID)** are listed separately in section *Hardware: PC Cards cifX* on page 9 in *Table 2*.

The **Slot Number (Card ID)** must be set at the PC card cifX using the **Rotary Switch Slot Number (Card ID)**. The **Slot Number (Card ID)** will serve to distinguish PC cards cifX from each other clearly, especially if several PC cards cifX are installed into the very same PC. The application program requests the **Slot Number (Card ID)** from the PC card cifX via the **cifX Device Driver**.



For further information refer to section *Rotary Switch for Slot Number (Card ID)* on page 103.

Requirements

For the application program is able to identify a PC card cifX via its **Slot Number (Card ID)** explicitly and to distinguish it from other PC cards cifX in the PC, for device revisions equipped with a **Rotary Switch for Slot Number (Card ID)** the required versions of the firmware, the driver, the bootloader and the SYCON.net setup must be used:

PC Cards with one Channel:

PC Card cifX	From Hardware Revision	Firmware File	Protocol	From Firmware Version	
CIFX 50-RE, CIFX 50-RE\ET, CIFX 50E-RE, CIFX 50E-RE\ET, CIFX 70E-RE, CIFX 70E-RE\MR, CIFX 100EH- RE\CUBE	3	CIFXECM.NXF	EtherCAT Master	2.4.3.x	
	1	CIFXECS.NXF	EtherCAT Slave	2.5.5.x	
	4	CIFXEIM.NXF	EtherNet/IP Scanner	2.2.1.x	
	1	CIFXEIS.NXF	EtherNet/IP Adapter	2.3.29.x	
	1	CIFXOMB.NXF	Open-Modbus/TCP	2.3.3.0	
	1	CIFXPXS.NXF	POWERLINK Controlled Node	2.1.19.x	
			CIFXPNM.NXF	PROFINET IO Controller	2.3.x.x
			CIFXPNS.NXF	PROFINET IO Device	3.3.6.x (V3)
			CIFXS3M.NXF	sercos Master	2.0.9.0
			CIFXS3S.NXF	sercos Slave	3.0.8.0
CIFX 50-DP, CIFX 50E-DP, CIFX 70E-DP, CIFX 70E-DP\MR	5	CIFXDPM.NXF	PROFIBUS DP Master	2.3.x.x	
	5	CIFXDPS.NXF	PROFIBUS DP Slave	2.3.x.x	
	1	CIFXMPI.NXF	PROFIBUS MPI Device	2.2.5.0	
	1				
CIFX 50-CO, CIFX 50E-CO, CIFX 70E-CO, CIFX 70E-CO\MR	5	CIFXCOM.NXF	CANopen Master	2.3.x.x	
	4	CIFXCOS.NXF	CANopen Slave	2.3.x.x	
	1				
CIFX 50-DN,	5	CIFXDNM.NXF	DeviceNet Master	2.2.x.x	

PC Card cifX	From Hardware Revision	Firmware File	Protocol	From Firmware Version
		CIFXDNS.NXF	DeviceNet Slave	2.2.x.x
CIFX 50-CC, CIFX 50E-CC	2 2	CIFXCPS.NXF	CC-Link Slave	2.4.x.x

Table 15: Firmware Versions for the Function Slot Number (Card I), (for 1 Channel Systems)

PC Cards PCI and PCI Express with two Channels:

PC Card cifX	From Hardware Revision	Firmware File	Protocol	From Firmware Version
CIFX 50-2DP	1	CIFX2DPM.NXF	PROFIBUS DP Master, 2 Kanäle	1.0.x.x
		CIFX2DPS.NXF	PROFIBUS DP Slave, 2 Kanäle	1.0.x.x
CIFX 50-2DP\CO	1	C0201040.NXF	PROFIBUS DP Master, 1 Channel + CANopen Master, 1 Channel	1.0.x.x
		C0202050.NXF	PROFIBUS DP Slave, 1 Channel + CANopen Slave, 1 Channel	1.0.x.x
CIFX 50-2DP\DN	1	C0201060.nxf	PROFIBUS DP Master, 1 Channel + DeviceNet Master, 1 Channel	1.0.x.x
		C0202070.nxf	PROFIBUS DP Slave, 1 Channel + DeviceNetSlave, 1 Channel	1.0.x.x
CIFX 50-2CO	1	C0204040.NXF	CANopen Master, 2 Channels	1.0.x.x
		C0204050.NXF	CANopen Master, 1 Channel + CANopen Slave, 1 Channel	1.0.x.x
		C0205050.NXF	CANopen Slave, 2 Channels	1.0.x.x
CIFX 50-2CO\DN	1	C0204060.NXF	CANopen Master, 1 Channel + DeviceNet Master, 1 Channel	1.0.x.x
		C0205070.NXF	CANopen Slave, 1 Channel + DeviceNet Slave, 1 Channel	1.0.x.x
CIFX 50-2DN	1	C0206060.NXF	DeviceNet Master, 2 Channels	1.0.x.x
		C0207070.NXF	DeviceNet Slave, 2 Channels	1.0.x.x
CIFX 50-2ASM, CIFX 50E-2ASM	2 2	CIFX2ASM.NXF	AS-Interface Master, 2 Channels	2.1.x.x

Table 16: Firmware Versions for the Function Slot Number (Card ID) (for 2 Channel Systems)

Driver and Software	Version or higher
cifX Device Driver	cifX Device Driver Setup.exe 0.95x
SYCON.net	SYCONnet netX setup.exe V1.201.x.x

Table 17: Versions Driver, Bootloader and SYCON.net for Function Slot Number (Card ID)

- The **cifX Device Driver** versions **0.950** and higher identify PC cards cifX alternatively via its **Slot Number (Card ID)** if this is supported by the hardware.
- The **cifX Device Driver** up to version **0.94x** identifies PC cards cifX via its device and serial number. For the device exchange service respectively a manual intervention is required.

3.6 The Function „DMA Mode“

Device revisions which provide **DMA Mode** are listed separately in section *Hardware: PC Cards cifX* on page 9 in *Table 2*.



Note: The functions **Slot Number (Card ID)** and **DMA Mode** are in technical view independently from each other.

The **DMA Mode** is activated via the device driver **cifX Device Driver**.



For further information refer to the user manual **Software Installation for the PC Cards cifX** in section *Activating DMA Mode in the cifX Device Driver Setup*.

Requirements

For device revisions providing the **DMA Mode** the required versions of the firmware, the driver and the SYCON.net setup must be used:

PC Cards with one Channel:

PC Card cifX	From Hardware Revision	Firmware File	Protocol	From Firmware Version	
CIFX 50-RE, CIFX 50-RE\ET, CIFX 50E-RE, CIFX 50E-RE\ET, CIFX 70E-RE, CIFX 70E-RE\MR, CIFX 100EH-RE\CUBE	1	CIFXECM.NXF	EtherCAT Master	2.4.6.0	
	1	CIFXECS.NXF	EtherCAT Slave	2.5.5.0	
	4	CIFXEIM.NXF	EtherNet/IP Scanner	2.2.x.x	
	1	CIFXEIS.NXF	EtherNet/IP Adapter	2.3.x.x	
	1	CIFXOMB.NXF	Open-Modbus/TCP	2.4.x.x	
	1	CIFXPLS.NXF	POWERLINK Controlled Node	2.1.24.0	
			CIFXPNM.NXF	PROFINET IO Controller	2.3.x.x
			CIFXPNS.NXF	PROFINET IO Device	3.4.x.x (V3)
			CIFXS3M.NXF	sercos Master	2.0.15.0
			CIFXS3S.NXF	sercos Slave	3.0.15.0
CIFX 50-DP, CIFX 50E-DP, CIFX 70E-DP, CIFX 70E-DP\MR	1	CIFXDPM.NXF	PROFIBUS DP Master	2.3.x.x	
	4	CIFXDPS.NXF	PROFIBUS DP Slave	2.3.x.x	
	1	CIFXMPI.NXF	PROFIBUS MPI Device	<i>not supported</i>	
	1				
CIFX 50-CO, CIFX 50E-CO, CIFX 70E-CO, CIFX 70E-CO\MR	1	CIFXCOM.NXF	CANopen Master	2.3.x.x	
	4	CIFXCOS.NXF	CANopen Slave	2.3.x.x	
	1				
CIFX 50-DN, CIFX 50E-DN, CIFX 70E-DN, CIFX 70E-DN\MR	1	CIFXDNM.NXF	DeviceNet Master	2.2.x.x	
	4	CIFXDNS.NXF	DeviceNet Slave	2.2.x.x	
	1				
CIFX 50-CC, CIFX 50E-CC	1	CIFXCCS.NXF	CC-Link Slave	2.4.x.x	
	3				

Table 18: Firmware Versions for the DMA Mode (for 1 Channel Systems)

PC Cards PCI and PCI Express with two Channels:

PC Card cifX	From Hardware Revision	Firmware File	Protocol	From Firmware Version
CIFX 50-2DP	1	CIFX2DPM.NXF	PROFIBUS DP Master, 2 Kanäle	1.0.x.x (new version counting)
		CIFX2DPS.NXF	PROFIBUS DP Slave, 2 Kanäle	1.0.x.x (new version counting)
CIFX 50-2DP\CO	1	C0201040.NXF	PROFIBUS DP Master, 1 Channel + CANopen Master, 1 Channel	1.0.x.x

PC Card cifX	From Hardware Revision	Firmware File	Protocol	From Firmware Version
		C0202050.NXF	PROFIBUS DP Slave, 1 Channel + CANopen Slave, 1 Channel	1.0.x.x
CIFX 50-2DP\DN	1	C0201060.NXF	PROFIBUS DP Master, 1 Channel + DeviceNet Master, 1 Channel	1.0.x.x
		C0205070.NXF	PROFIBUS DP Slave, 1 Channel + DeviceNetSlave, 1 Channel	1.0.x.x
CIFX 50-2CO	1	C0204040.NXF	CANopen Master, 2 Channels	1.0.x.x
		C0204050.NXF	CANopen Master, 1 Channel + CANopen Slave, 1 Channel	1.0.x.x
		C0205050.NXF	CANopen Slave, 2 Channels	1.0.x.x
CIFX 50-2CO\DN	1	C0204060.NXF	CANopen Master, 1 Channel + DeviceNet Master, 1 Channel	1.0.x.x
		C0205070.NXF	CANopen Slave, 1 Channel + DeviceNet Slave, 1 Channel	1.0.x.x
CIFX 50-2DN	1	C0206060.NXF	DeviceNet Master, 2 Channels	1.0.x.x
		C0207070.NXF	DeviceNet Slave, 2 Channels	1.0.x.x
CIFX 50-2ASM, CIFX 50E-2ASM	2 4	CIFX2ASM.NXF	AS-Interface Master, 2 Channels	2.1.x.x

Table 19: Firmware Versions for the DMA Mode (for 2 Channel Systems)

Driver and Software	Version or higher
cifX Device Driver	cifX Device Driver Setup.exe 0.95x
SYCON.net	SYCONnet netX setup.exe V1.201.x.x

Table 20: Versions Driver and SYCON.net for the DMA Mode

3.7 PC Cards cifX with additional MRAM

The PC cards CIFX 70E-XX\MR (CIFX 70E-RE\MR, CIFX 70E-DP\MR, CIFX 70E-CO\MR and CIFX 70E-DN\MR) are identical to the PC cards CIFX 70E-XX and work with the same firmware. However, the PC cards CIFX 70E-XX\MR have an additional memory module for storing remanent data, MRAM with 128Kbyte (= 64K words). Using the cifX Device Driver (from Version 1.1.1.0) access from the application program to this memory is possible and it can be used as a remanent memory for the host system.

3.8 System Requirements

3.8.1 Slot for the PC Cards cifX PCI, PCIe and Low Profile PCIe

PC with slot (3.3 V) for PC cards cifX *PCI*, *PCI Express* and *Low Profile PCI Express*:

PC Cards cifX	PCI Bus [Pins]	Slot
CIFX 50-RE CIFX 50-RE\ET CIFX 50-DP CIFX 50-2DP CIFX 50-2DP\CO CIFX 50-2DP\DN CIFX 50-CO CIFX 50-2CO CIFX 50-2CO\DN	124	PCI slot (3.3 V)
CIFX 50E-RE CIFX 50E-RE\ET CIFX 50E-DP CIFX 50E-CO CIFX 50E-DN CIFX 50E-2ASM CIFX 50E-CC	CIFX 70E-RE, CIFX 70E-RE\MR, CIFX 70E-DP, CIFX 70E-DP\MR, CIFX 70E-CO, CIFX 70E-CO\MR, CIFX 70E-DN, CIFX 70E-DN\MR	36 PCI Express x1 slot (3.3 V), x1 ¹ = One Lane [bus spec 3]
<div style="background-color: #0070C0; color: white; padding: 2px; text-align: center; font-weight: bold;">NOTICE</div> <p>Device Destruction!</p> <p>The PC card CIFX 100EH-RE\CUBE may not be installed in standard PCs.</p> <p>The pin assignment of the PCI Express bus does not meet the standard [bus spec 3]. By consequence malfunction can occur at the PCI express bus.</p> <p>Install the PC card CIFX 100EH-RE\CUBE exclusively in KEBA KeControl industry PCs series CP 3XX (Cube).</p>		
CIFX 100EH-RE\CUBE	64	PCI Express x4 slot (3.3 V) , x4 ¹ = Four Lane In the PCI Express x4 slot only lane 0 is used. For further details refer to section <i>Pin Assignment for PCI Express Bus CIFX 100EH-RE\CUBE</i> on page 108.

Table 21: Slot for the PC Cards cifX PCI, PCIe and Low Profile PCIe

¹ The terms "x1" or "x4" refer to the convention of the PCI Express specifications [bus spec 3] to the number of lanes in the slot.

3.8.2 Power Supply and Host Interface

For the power supply and the host interface used for the PC cards cifX *PCI*, *PCIe* and *Low Profile PCIe* you must observe the following requirements:

PC Cards cifX	Supply Voltage	Signaling Voltage Host Interface	Host Interface (PCI slot)
CIFX 50-RE CIFX 50-RE\ET CIFX 50-DP CIFX 50-2DP, CIFX 50-2DP CIFX 50-2DP\CO CIFX 50-2DP\DN CIFX 50-CO CIFX 50-2CO CIFX 50-2CO\DN	CIFX 50-DN CIFX 50-2DN CIFX 50-CC CIFX 50-2ASM	+3,3 V dc ±5 %/ Max. 1 A	5 V or 3.3 V PCI
CIFX 50E-RE CIFX 50E-RE\ET CIFX 50E-DP CIFX 50E-CO CIFX 50E-DN CIFX 50E-2ASM CIFX 50E-CC CIFX 100EH-RE\CUBE	CIFX 70E-RE, CIFX 70E-RE\MR, CIFX 70E-DP, CIFX 70E-DP\MR, CIFX 70E-CO, CIFX 70E-CO\MR, CIFX 70E-DN, CIFX 70E-DN\MR	+3,3 V dc ±5 %/ Max. 1 A	PCIe-compatible PCI Express

Table 22: Requirements Power Supply and Host Interface for PC Cards cifX *PCI*, *PCIe* *Low Profile PCIe*

The data in the *Table 22* above have the following meaning:

Supply Voltage

The required and permissible supply voltage at the PC card cifX *PCI*, *PCIe* and *Low Profile PCIe*.



Note: To ensure that the compatibility between different systems is guaranteed, providing a maximum of 1 A (for +3,3 VDC ±5 %) is recommended.

The typical current depends on the type of the PC card cifX. For detailed values on the typical current see section *Technical Data PC Cards cifX* on page 109.

Signaling Voltage Host Interface

The required or tolerated signaling voltage at the I/O signal pins at the PCI bus of the PC cards cifX *PCI* or at the PCI express bus of the PC cards cifX *PCIe* and *Low Profile PCIe*.

Host Interface (PCI slot) Type of the host interface

3.8.3 Operating Temperature Range for UL Certificate

The UL certificate for the PC cards cifX is valid for the range 0°C to 55°C.

Regardless of this the PC cards cifX are designed for the operating temperatures (-20°C to +55°C or -20°C to +70°C) as specified in section *Technical Data PC Cards cifX* on page 109.

3.9 Requirements for Operation of the PC Card cifX

Operating the PC cards cifX properly, the following described requirements must be fulfilled.



Protocols	EtherCAT Slave, EtherCAT Master, EtherNet/IP Adapter (Slave), EtherNet/IP Scanner (Master), Open-Modbus/TCP, POWERLINK-Controlled-Node/Slave, PROFINET IO Device (Slave), PROFINET IO Controller (Master),	sercos Slave, sercos Master, VARAN Client (Slave), PROFIBUS DP Slave, PROFIBUS DP Master, PROFIBUS MPI Device, CANopen Slave, CANopen Master,	DeviceNet Slave, DeviceNet Master, AS-Interface Master; CC-Link Slave
Software Installation	<p>1. Driver for the Host Interface Host Interfaces: PCI and PCI Express</p> <ul style="list-style-type: none"> The device driver cifX Device Driver must be installed (from V1.0.x.x). If you install the device into a PC, in general Windows® will be available as operating system. In this case the cifX Device Driver must be installed to communicate to the device and to exchange data via the dual-port memory,. <p> Important! Upgrade older versions of the cifX Device Driver necessarily on the current version indicated in section <i>Driver and Software</i> on page 10.</p> <hr/> <p>OR</p> <ul style="list-style-type: none"> If Windows® is not available as operating system, an own driver must be developed using the cifX Driver Toolkit and this driver must be installed. For the operating systems Linux, Windows® CE, VxWorks, QNX and IntervalZero RTX™ you can buy Device Driver at the company Hilscher Gesellschaft für Systemautomation mbH http://www.hilscher.com/. <p>2. The configuration software SYCON.net or alternatively the simple Slave configuration tool netX Configuration Tool must be installed or another application program by which the PC card cifX (Slave) can be parameterized.</p>		
How to use the Software	<p>On how to use the software for the configuration, the firmware download and for the diagnosis, note the following notice:</p> <p> Important! The <u>USB interface</u>, the <u>serial interface</u> as well as the <u>cifX Device Driver</u> may only be used exclusively by one software, that is</p> <ul style="list-style-type: none"> - the SYCON.net configuration software (with integrated ODMV3) or - the netX Configuration Tool or - the cifX Test Application or - the cifX Driver Setup Utility or - the application program. <p>Never use the listed software simultaneously, otherwise this will result in communication problems with the device. If the SYCON.net configuration software was used on the PC, then stop the ODMV3 service before you use one of the other software listed above. Therefore, select Service > Stop from the context menu of the ODMV3 system tray icon.</p>		
Firmware Download	<p>3. Using the configuration software SYCON.net or for the Slave alternatively the Slave configuration tool netX Configuration Tool, the user must select and download the firmware to the PC card cifX.</p>		
Parameter Setting	<p>4. The PC card cifX must be parameterized using one of the following options:</p> <ul style="list-style-type: none"> Configuration Software SYCON.net alternatively Slave configuration tool netX Configuration Tool (only Slave) Application program (programming required) 		
Communication	<p>5. For the communication of a PC card cifX (Slave) a Master device for the respective communication system is required. For the communication of a PC card cifX (Master) a Slave device for the respective communication system is required.</p>		
PC Settings for PC Cards cifX PCI Express	<p> Important! If you install a PC card cifX PCI Express, you <u>always</u> must disable the Microsoft Windows "Link State Power Management". Otherwise, it cannot be excluded that your PC freezes during the PC card cifX PCI Express is in operation.</p>		
Environmental Conditions	<p>Due to a plug element from ERNI the lower limit of the operating temperature for all PC cards cifX Real-Time Ethernet is 0 °C. This applies to all hardware revisions of the PC card cifX Real-Time Ethernet.</p>		





Table 23: Requirements to operate PC Cards cifX properly



4 Getting Started

4.1 Installation and Configuration PC Card cifX

The following table describes the steps for the software and hardware installation and for the configuration of a PC card cifX (Master and Slave) Real-Time Ethernet and fieldbus as it is typical for many cases. The Slave device can be configured using the corresponding Slave DTM in the configuration software **SYCON.net**. Alternatively, you can also use the simple Slave configuration tool **netX Configuration Tool**. The Master device can be configured using the corresponding Master DTM in the configuration software **SYCON.net**.

#	Step	Description	For detailed information see manual / section	Page
1	Installing Driver and Software			
1.1	Installing cifX Device Driver	Enter the Communication Solutions DVD in the PC and follow to the instructions of the installation wizard, to install the driver.	<i>Refer to User Manual Software Installation for the PC cards cifX</i>	
1.2	Installing SYCON.net	<u>For PC Cards cifX Master or Slave:</u> Run the SYCON.net-Setup and follow to the instructions of the installation wizard.		
1.3	Installing netX Configuration Tool	<u>For PC Cards cifX Slave:</u> Start the netX Configuration Tool setup program to install the netX Configuration Tool .		
2	Preparing Hardware Installation			
2.1	Take precautions on Electrostatically sensitive Devices	<div style="background-color: #0056b3; color: white; padding: 2px; text-align: center; font-weight: bold;">NOTICE</div> <p>Electrostatically sensitive Devices Make sure, that the PC card cifX is grounded via the endplate and the PC and make sure, that you are discharged when you install/ uninstall the PC card cifX.</p>	<i>Electrostatically sensitive Devices</i>	24
2.2	Glue sticker on the front plate.	<u>For CIFX 50-RE, CIFX 50E-RE, CIFX 70E-RE, CIFX 70E-RE\MR and CIFX 100EH-RE\CUBE</u>	<i>Fix Front Plate Sticker</i>	72
2.2	Set the Slot Number (Card ID)	Value 0 or a value from 1 to 9	<i>Rotary Switch for Slot Number (Card ID)</i>	103
3	Hardware Installation	Installing cifX. Take required safety precautions.	<i>Hardware Installation and Uninstalling</i>	70
3.1	Take safety precautions	<div style="background-color: #ff9900; color: white; padding: 2px; text-align: center; font-weight: bold;">⚠ WARNING</div> <p>Lethal Electrical Shock caused by parts with more than 50V! Disconnect the power plug of the PC or of the connecting device. Make sure, that the power supply is off at the PC or at the connecting device.</p>	<i>Electrical Shock Hazard</i>	22
3.2	Open cabinet	Now open the cabinet of the PC or of the connecting device.	<i>Installing PC Card cifX PCI, PCIe, Low Profile PCIe</i>	75

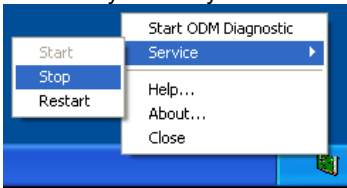
#	Step	Description	For detailed information see manual / section	Page
3.3	Installing cifX	<p>Plug in and mount the PC card cifX.</p> <p><u>Notice for CIFX 100EH-RE\CUBE:</u></p> <p>NOTICE</p> <p>Device Destruction!</p> <p>Install the PC card CIFX 100EH-RE\CUBE exclusively in KEBA KeControl industry PCs series CP 3XX (Cube). Otherwise yy consequence malfunction can occur at the PCI express bus.</p>		
3.4	Close cabinet	Close the cabinet of the PC or connecting device.		
3.5	Plug the connecting cable to the Master or Slave	<p><u>Note for all PC Cards cifX Real-Time Ethernet:</u></p> <p> Note! The RJ45 socket is only for use in LAN, not for telecommunication circuits.</p> <p><u>Note for PC Cards cifX PROFINET IO Controller:</u></p> <p> Important for Hardware Wiring! Connect only ports with each other, which have different cross-over settings. Otherwise a connection between the devices can not be established. If the port settings of the PC card cifX PROFINET IO controller are not set to AUTO, then Port0 is switched uncrossed and Port1 crossed.</p> <p>Plug in the connecting cable from the PC card cifX to the PC card Master or Slave.</p>	<p><i>Ethernet Interface</i></p> <p><i>See corresponding user manual</i></p>	98
3.6	Connect the PC to the power / switch on.	Connect the PC or the connecting device to the power supply and switch it on.		
4	Hardware Settings	Hardware Settings in the Driver Setup		
4.1	Set Slot Number (Card ID)	Set in the cifX Device Driver Setup the Slot Number (Card ID) which has been set at the PC card cifX (hardware).	<i>Refer to User Manual Software Installation for the PC Cards cifX</i>	
4.2	DMA Mode in the cifX Device Driver Setup	Activate the DMA Mode in the cifX Device Driver Setup.		
5	PC Settings			
5.1	for PC Cards cifX PCI Express	<p> Important! If you install a PC card cifX PCI Express, you <u>always</u> must disable the Microsoft Windows "Link State Power Management". Otherwise, it cannot be excluded that your PC freezes during the PC card cifX PCI Express is in operation.</p>	<i>Refer to User Manual Software Installation for the PC Cards cifX</i>	
6	Notice on how to use the Software	Use only one Software.		
6.1	<u>For the configuration, the firmware download and for the diagnosis, note:</u>	<p> Important! To avoid communication problems with the device, use the <u>USB interface</u>, the <u>serial interface</u> as well as the <u>cifX Device Driver</u> exclusively with one software that is SYCON.net or netX Configuration Tool.</p>	<i>Requirements for Operation of the PC Card cifX</i>	34

#	Step	Description	For detailed information see manual / section	Page
7	Configuring Slave using SYCON.net	Download Firmware and Configuration Use the corresponding Slave DTM in the configuration software SYCON.net .		
7.1	Firmware Download	<ul style="list-style-type: none"> - Start configuration software SYCON.net, - Create new project /Open existing project, - Insert Slave into configuration, - Select driver and assign device. - Select and download the firmware. 	See corresponding user manual <i>Device Names in SYCON.net</i>	40
	<i>Firmware Slave:</i>	EtherCAT Slave, PROFIBUS DP Slave, EtherNet/IP Adapter, PROFIBUS MPI Open-Modbus/TCP, Device, POWERLINK- CANopen Slave, Controlled-Node/Slave, DeviceNet Slave, PROFINET IO Device, CC-Link Slave sercos Slave, VARAN Client,		
7.2	Configuration cifX (Slave)	-Configure the PC card cifX (Slave).		
7.3	Download Configuration	- Download the configuration to the PC card cifX (Slave)		
8	OR Configuring Slave using netX Configuration Tool	Download Firmware and Configuration		
8.1	Downloading Firmware and Configuration (Slave)	If SYCON.net was already used on the PC, stop the ODMV3 service. Therefore, select Service > Stop from the context menu of the ODMV3 system tray icon.  The ODMV3 system tray icon changes to ODMV3 Service stopped .  In the netX Configuration Tool : <ul style="list-style-type: none"> - select the Firmware protocol, - Set the PC card cifX (Slave) parameters. - Select Apply. The selected firmware and the configuration are downloaded to the replacement card cifX. The configuration is saved to the hard disk of the PC.	<i>Requirements for Operation of the PC Card cifX</i> <i>See Operating Instruction Manual netX Configuration Tool for cifX, comX and netJACK</i>	34
9	Configuring Master using SYCON.net	Download Firmware and Configuration Use the corresponding Master DTM in the configuration software SYCON.net .		
9.1	Firmware Download	<ul style="list-style-type: none"> - Start configuration software SYCON.net, - Create new project /Open existing project, - Insert Master into configuration, - Select driver and assign device. - Select and download the firmware. 	See corresponding user manual <i>Device Names in SYCON.net</i>	40
	<i>Firmware Master:</i>	EtherCAT Master, PROFIBUS DP Master, EtherNet/IP Scanner, CANopen Master, PROFINET IO DeviceNet Master, Controller, AS-Interface Master		
9.2	Configuration cifX (Master)	- Configure the PC card cifX (Master).		<i>Notes for the Configuration of the</i>

#	Step	Description	For detailed information see manual / section	Page
9.3	Download Configuration	- Download the configuration to the PC card cifX (Master).	<i>Master Device</i>	
10	Slave Diagnosis by SYCON.net (Slave and Master)	Diagnosis, I/O Data Use the corresponding Slave or Master DTM in the configuration software SYCON.net .		
10.1	Diagnostic	- Rightclick on the device symbol. - Select context menu entry Diagnosis , then select Diagnosis > General or Firmware Diagnosis , - or select Diagnosis > Extended Diagnosis .	<i>See corresponding user manual</i>	
10.2	I/O Monitor	- Rightclick on device symbol. - Select context menu entry Diagnosis , then Tools > IO Monitor . - Check the input or output data.		
11	OR Slave Diagnosis by netX Configuration Tool (only Slave)	Diagnosis		
11.1	Configuration Steps cifX (Slave)	If SYCON.net was already used on the PC, stop the ODMV3 service. Therefore, select Service > Stop from the context menu of the ODMV3 system tray icon. In the netX Configuration Tool : - In the navigation area click on Diagnostic , - click in the Diagnostic pane to Start , to start the communication to the Master device and to run the diagnosis. - click on Extended , to run the extended diagnosis.	<i>See Operating Instruction Manual netX Configuration Tool for cifX, comX and netJACK</i>	

Table 24: Steps for the Software and Hardware Installation, the Configuration and for the Diagnosis of a PC Card cifX (Master and Slave)

4.2 Note on Exchange Service (Replacement Case)

For the exchange service (replacement case) of a PC card cifX (Master and Slave) obey to the following note.



Important! For the replacement card cifX *with* **Rotary Switch Slot Number (Card ID)** set the same **Slot Number (Card ID)** as at the previous PC card cifX (see section *Rotary Switch for Slot Number (Card ID)* on page 103).

For PC cards cifX *without* **Rotary Switch Slot Number (Card ID)** in terms of a device exchange service (replacement case) you must manually download the same firmware and configuration into the replacement card cifX, as into the preceding cifX.

4.3 Notes for the Configuration of the Master Device

To configure the Master, a device description file is required. Please note the following notes for the configuration of the Master Device:

System	Note
<i>EtherCAT Slave</i>	To configure the Master, an XML file (device description file) is required. The settings in the used Master must comply with the settings in the Slave to establish communication. Important parameters are: Vendor ID, Product Code, Serial Number, Revision Number, Output and Input Data Bytes.

System	Note
<i>EtherCAT Slave</i>	<p>If the XML file <i>Hilscher cifX RE ECS V2.2.x.xml</i> is use/updated, the firmware with the version 2.2.x must be use/updated.</p> <p>The loadable firmware supports for the number of cyclic input data and for cyclic output data in total up to 400 bytes. If more than 200 bytes for input data or for output data should be exchanged via EtherCAT, then a customer specific XML file is necessary. Additionally the following formular applies: $(\text{number of input bytes} + 3)/4 + (\text{number of output bytes} + 3)/4$ must be less or equal to 100.</p>
<i>EtherNet/IP Adapter</i>	To configure the Scanner/Master, an EDS file (device description file) is required. The settings in the used Scanner/Master must comply with the settings in the Adapter/Slave to establish communication. Important parameters are: Input, Output Data Bytes, Vendor ID, Product Type, Product Code, Major Rev, Minor Rev, IP Address and Netmask.
<i>POWERLINK-Controlled-Node/Slave</i>	To configure the Managing Node/Master, an XDD file (device description file) is required. The settings in the used Managing Node/Master must comply with the settings in the Controlled Node/Slave, to establish communication. Important parameters are: Vendor ID, Product Code, Serial Number, Revision Number, Node ID, Output and Input length.
<i>PROFINET IO Device</i>	To configure the Controller, a GSDML file (device description file) is required. The settings in the used Controller must comply with the settings in the Device to establish communication. Important parameters are: Station Name, Vendor ID, Device ID, Input and Output Data Bytes. Under Name of Station, the name must be typed which was also used in the configuration file of the master of this device. If no name chosen freely is used in the configuration file, then the name from the GSDML file is used.
<i>sercos Slave</i>	<p>The sercos Master uses the sercos address to communicate with the slave. Some Masters will verify Device ID, Vendor Code, Input Data Size and Output Data Size and will do further communication to the Slave only if all these values match. Therefor the Master reads these parameters from the Slave and compares them with the configuration stored in the Master.</p> <p>The parameters Device ID, Vendor Code, Input Data Size and Output Data Size are part of the SDDML device description file. If for the configuration of the sercos Master SDDML files are used and a default value of one of these parameters was changed, then a SDDML file must be created in the configuration software via Export SDDML and then used in the configuration of the sercos Master.</p>
<i>PROFIBUS DP Slave</i>	To configure the Master, a GSD file (device description file) is required. The settings in the used Master must comply with the settings in the Slave to establish communication. Important parameters are: Station Address, Ident Number, Baudrate and Config Data (the configuration data for the output and input length).
<i>CANopen Slave</i>	To configure the Master, an EDS file (device description file) is required. The settings in the used Master must comply with the settings in the Slave to establish communication. Important parameters are: Node Address and Baudrate.
<i>DeviceNet Slave</i>	To configure the Master, an EDS file (device description file) is required. The settings in the used Master must comply with the settings in the Slave to establish communication. Important parameters are: MAC ID, Baudrate, Produced Size, Consumed Size, Vendor ID, Product Type, Product Code, Major Rev, Minor Rev.
<i>CC-Link Slave</i>	To configure the Master, a CSP file (device description file) is required. The settings in the used Master must comply with the settings in the Slave to establish communication. Important parameters are: Slave Station Address, Baudrate, Station Type and Vendor Code.

Table 25: Notes for the Configuration of the Master Device



Further information to the device description files you find under section on *Device Description Files PC Cards cifX* page 16.

4.4 Device Names in SYCON.net

The following table contains the device names displayed for the single communication protocols in the configuration software SYCON.net.

The table shows the PC card cifX and which protocol can be used. Furthermore, the table shows, for which protocol which device must be selected from the device catalog to configure the PC card cifX with SYCON.net.

PC Cards cifX	Protocol	DTM Specific Group	Device Name in SYCON.net
CIFX 50-RE, CIFX 50-RE\ET, CIFX 50E-RE, CIFX 50E-RE\ET CIFX 70E-RE, CIFX 70E-RE\MR, CIFX 100EH-RE\CUBE	EtherCAT Master	Master	CIFX RE/ECM
	EtherCAT Slave	Gateway/Stand-Alone Slave	CIFX RE/ECS
	EtherNet/IP Scanner (Master)	Master	CIFX RE/EIM
	EtherNet/IP Adapter (Slave)	Gateway/Stand-Alone Slave	CIFX RE/EIS
	Open-Modbus/TCP	Gateway/Stand-Alone Slave	CIFX RE/OMB
	POWERLINK-Controlled-Node/Slave	Gateway/Stand-Alone Slave	CIFX RE/PLS
	PROFINET IO-Controller	Master	CIFX RE/PNM
	PROFINET IO-Device	Gateway/Stand-Alone Slave	CIFX RE/PNS
	sercos Master	Master	CIFX RE/S3M
	sercos Slave	Gateway/Stand-Alone Slave	CIFX RE/S3S
	VARAN Client (Slave)	Gateway/Stand-Alone Slave	CIFX RE/VRS
CIFX 50-DP, CIFX 50E-DP, CIFX 70E-DP, CIFX 70E-DP\MR	PROFIBUS DP Master	Master	CIFX DP/DPM
	PROFIBUS DP Slave	Gateway/ Stand-Alone Slave	CIFX DP/DPS
	PROFIBUS MPI Device	Gateway/ Stand-Alone Slave	CIFX DP/MPI
CIFX 50-2DP	PROFIBUS DP Master	Master	2*CIFX DP/DPM <i>for each PROFIBUS DP channel one CIFX DP/DPM</i>
	PROFIBUS DP Slave	Gateway/ Stand-Alone Slave	2*CIFX DP/DPS <i>for each PROFIBUS DP channel one CIFX DP/DPS</i>
CIFX 50-2DP\CO	PROFIBUS DP Master, CANopen Master	Master	1*CIFX DP/DPM, <i>for PROFIBUS DP channel one CIFX DP/DPM</i> 1*CIFX CO/COM, <i>for CANopen channel one CIFX CO/COM</i>
	PROFIBUS DP Slave, CANopen Slave	Gateway/ Stand-Alone Slave	1*CIFX DP/DPS, <i>for PROFIBUS DP channel one CIFX DP/DPS</i> 1*CIFX CO/COS, <i>for CANopen channel one CIFX CO/COS</i>
CIFX 50-2DP\DN	PROFIBUS DP Master, DeviceNet Master	Master	1*CIFX DP/DPM, <i>for PROFIBUS DP channel one CIFX DP/DPM</i> 1*CIFX DN/DNM, <i>for DeviceNet channel one CIFX DN/DNM</i>
	PROFIBUS DP Slave, DeviceNet Slave	Gateway/ Stand-Alone Slave	1*CIFX DP/DPS, <i>for PROFIBUS DP channel one CIFX DP/DPS</i> 1*CIFX DN/DNS,

PC Cards cifX	Protocol	DTM Specific Group	Device Name in SYCON.net
			<i>for DeviceNet channel one CIFX DN/DNS</i>
CIFX 50-CO CIFX 50E-CO, CIFX 70E-CO, CIFX 70E-COMR	CANopen Master	Master	CIFX CO/COM
	CANopen Slave	Gateway/ Stand-Alone Slave	CIFX CO/COS
CIFX 50-2CO	CANopen Master	Master	2* CIFX CO/COM <i>for each CANopen channel one CIFX CO/COM</i>
	CANopen Master, CANopen Slave	Master, Gateway/ Stand-Alone Slave	1* CIFX CO/COM, <i>for 1 CANopen channel one CIFX CO/COM</i> 1* CIFX CO/COS, <i>for 1 CANopen channel one CIFX CO/COS</i>
	CANopen Slave	Gateway/Stand-Alone Slave	2*CIFX CO/COS <i>for each CANopen channel one CIFX CO/COS</i>
CIFX 50-CO/DN	CANopen Master, DeviceNet Master	Master	1* CIFX CO/COM, <i>for CANopen channel one CIFX CO/COM</i> 1*CIFX DN/DNM, <i>for DeviceNet channel one CIFX DN/DNM</i>
	CANopen Slave, DeviceNet Slave	Gateway/Stand-Alone Slave	1* CIFX CO/COS, <i>for CANopen channel one CIFX CO/COS</i> 1* CIFX DN/DNS, <i>for DeviceNet channel one CIFX DN/DNS</i>
CIFX 50-DN CIFX 50E-DN, CIFX 70E-DN	DeviceNet Master	Master	CIFX DN/DNM
	DeviceNet Slave	Gateway/ Stand-Alone Slave	CIFX DN/DNS
CIFX 50-2DN, CIFX 70E-DNMR	DeviceNet Master	Master	2* CIFX DN/DNM <i>for each DeviceNet channel one CIFX DN/DNM</i>
	DeviceNet Slave	Gateway/Stand-Alone Slave	2* CIFX DN/DNS <i>for each DeviceNet channel one CIFX DN/DNS</i>
CIFX 50-2ASM, CIFX 50E-2ASM	AS-Interface Master	Master	CIFX AS/ASM <i>for each AS-Interface channel one CIFX AS/ASM</i>
CIFX 50-CC CIFX 50E-CC	CC-Link Slave	Slave	CIFX CC/ CCS

Table 26: Device Names in SYCON.net by Communication Protocol

4.5 Update for Firmware, Driver and Software



Note: As a pre-requirement for the software update the project files, the configuration files and firmware files are to be saved.

At existing hardware installation the firmware, the driver and the configuration software must be updated according to the versions given in section *Notes on Hardware, Firmware, Software and Driver Versions* on page 9. The following graphic gives an overview:

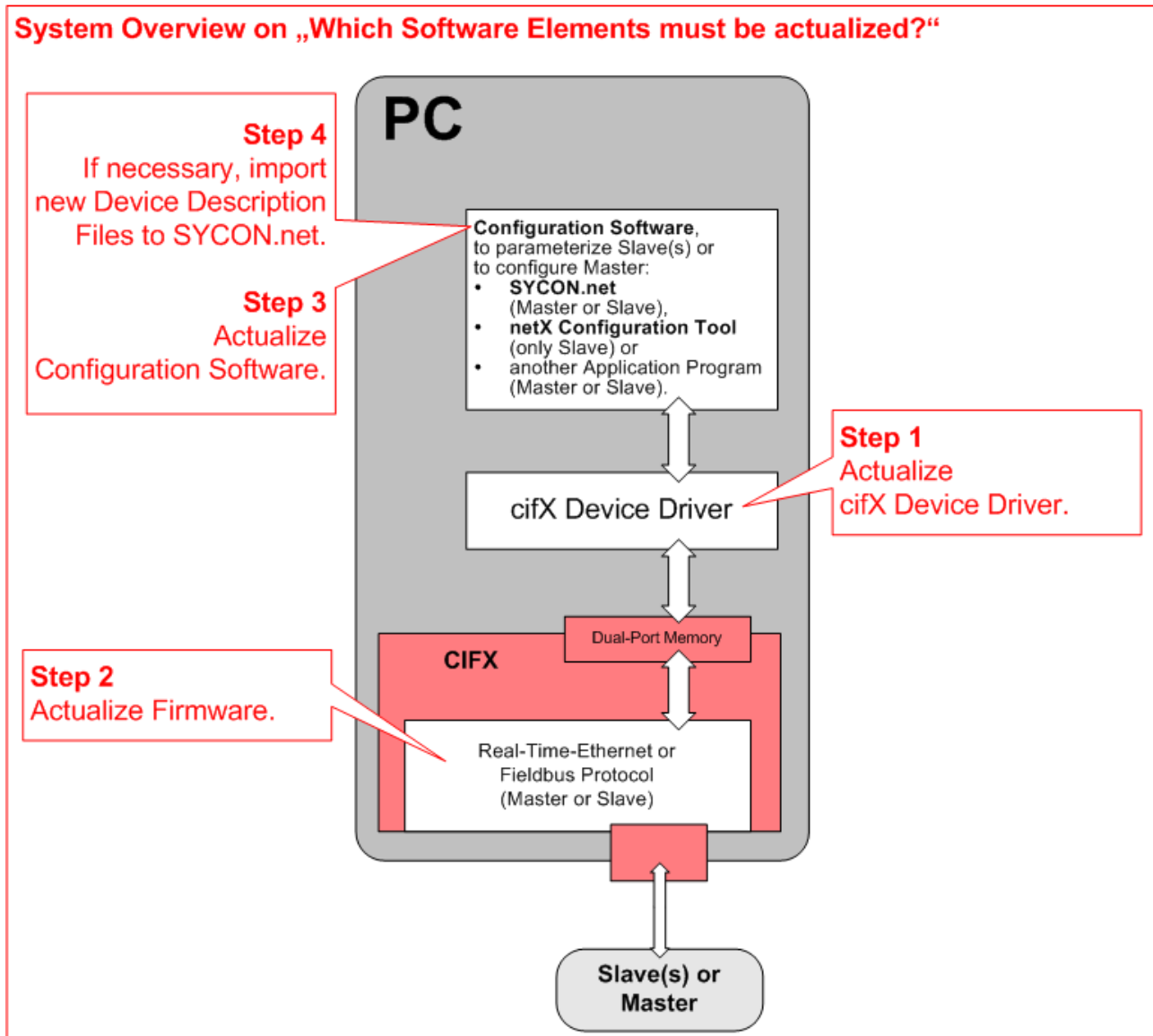

Figure 1: System Overview cifX to update Firmware, Driver and Software



Note the specific details for devices with **Rotary Switch Slot Number (Card ID)** in the section *The Function „Slot Number (Card ID)“* on page 28 or **DMA Mode** in section *The Function „DMA Mode“* on page 30.

5 Device Drawings

5.1 PC Cards cifX PCI and PCI Express

5.1.1 CIFX 50-RE, CIFX 50-RE\ET, CIFX 50E-RE, CIFX 50E-RE\ET

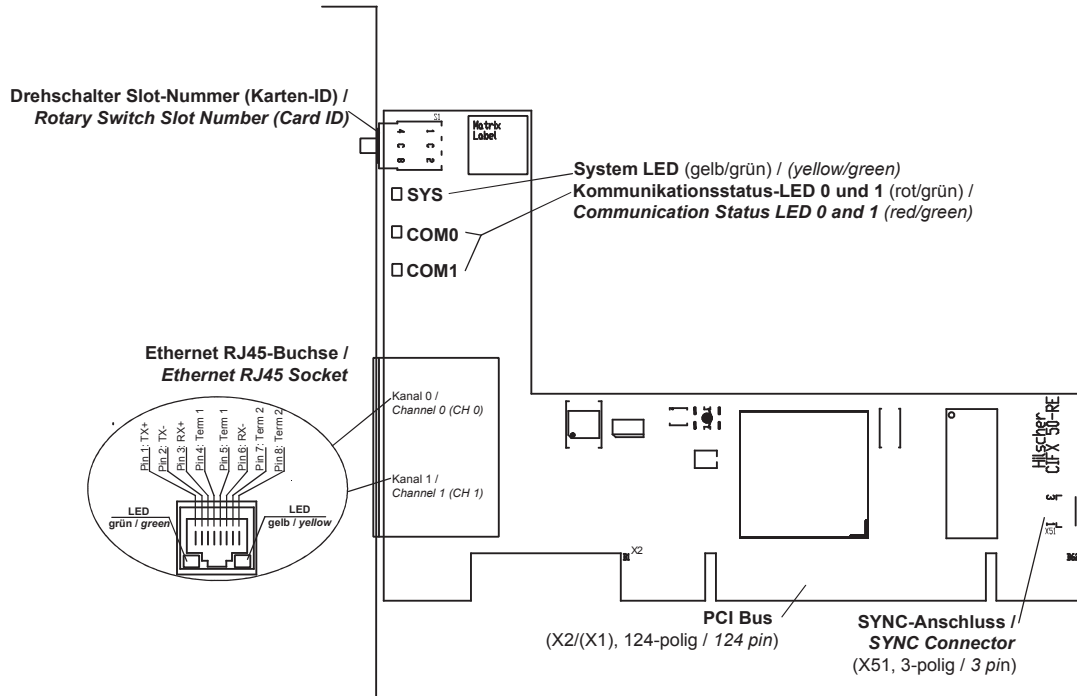

Figure 2: CIFX 50-RE* (from hardware rev. 3), CIFX 50-RE\ET* (from hardware rev. 1)

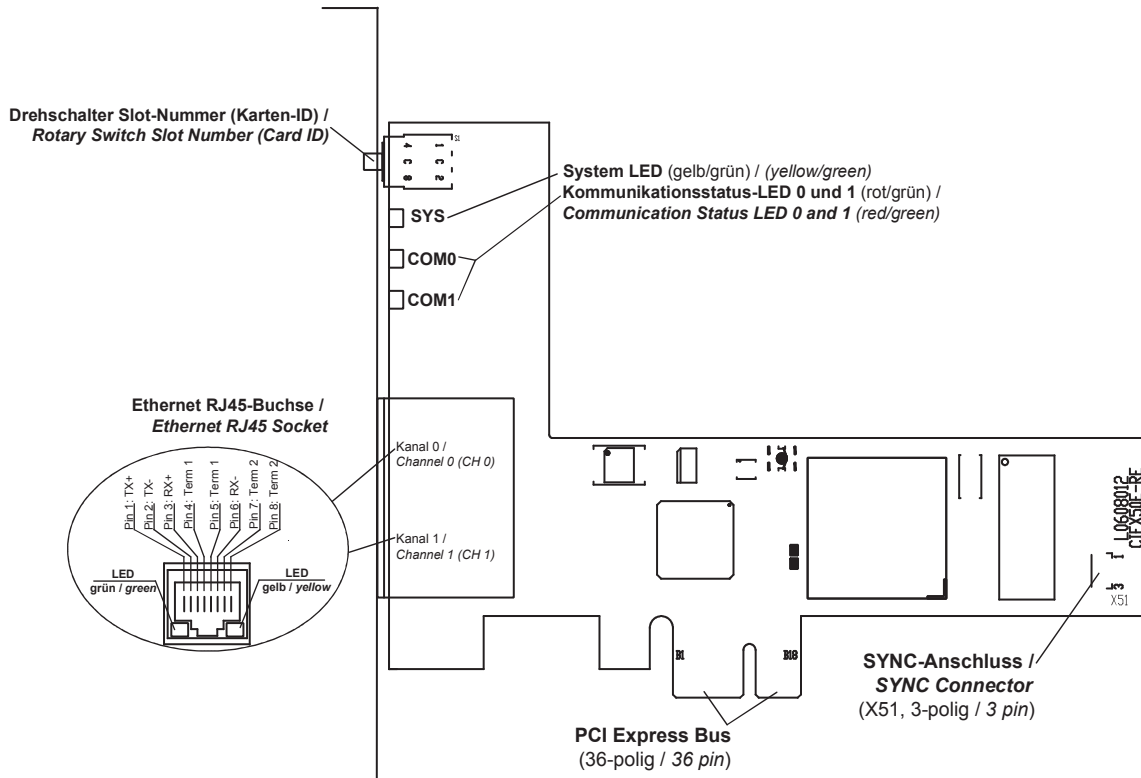

Figure 3: CIFX 50E-RE* (from hardware rev. 4), CIFX 50E-RE\ET* (from hardware rev. 1)



Note: *Device supports Auto Crossover Function. Note also: With loaded EtherCAT Master firmware only the RJ45 channel 0 can be used, channel 1 is deactivated. Beginning with EtherCAT Master firmware V3 channel 1 can be reactivated if redundancy is activated. For Open Modbus/TCP with V2.3.4.0 and higher both RJ45 channels can be used.



For the **SYNC** pin assignment of the SYNC Connector refer to section *Pin Assignment SYNC Connector, X51* (CIFX 50 50E 70E) on page 105. Device drawings of earlier device revisions without rotary switch slot number (card ID) are included in the user manual for PC cards cifX Real-Time Ethernet up to manual rev. 32.

The figure below shows the front plate of the PC cards CIFX 50-RE, CIFX 50-RE\ET, CIFX 50E-RE or CIFX 50E-RE\ET:

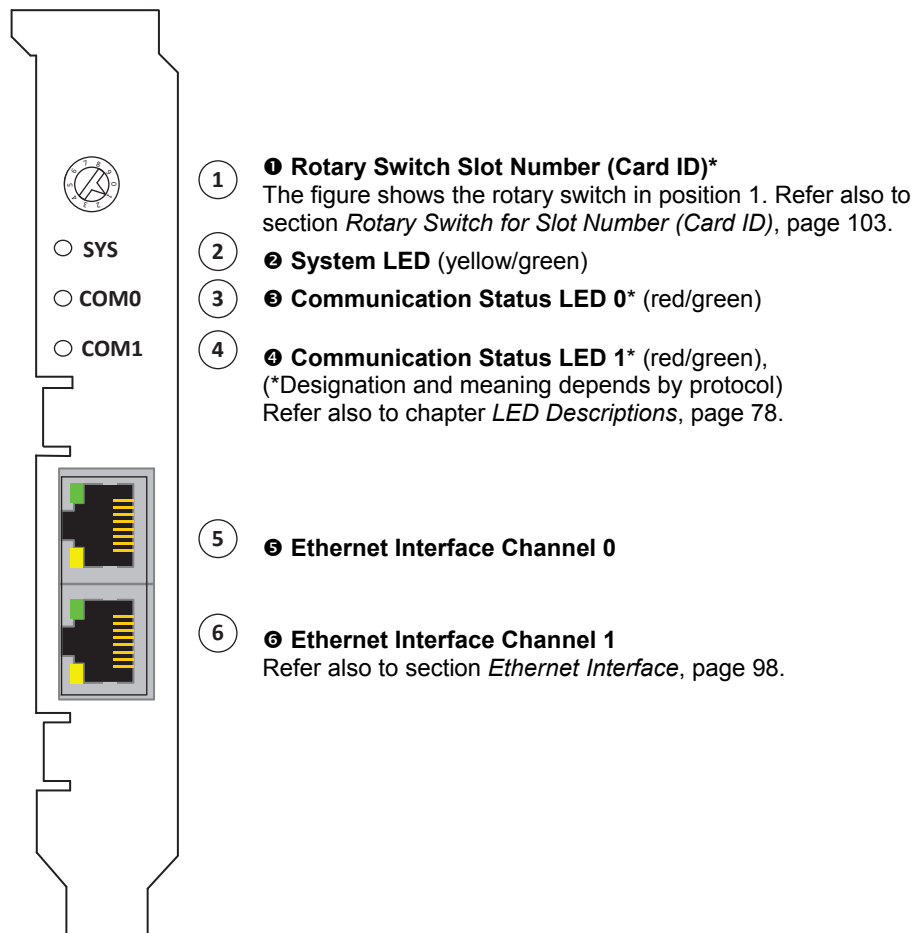

Figure 4: Front Plate for CIFX 50-RE, CIFX 50-RE\ET, CIFX 50E-RE or CIFX 50E-RE\ET

*From hardware revision 3 (for CIFX 50-RE), 1 (for CIFX 50-RE\ET), 4 (for CIFX 50E-RE) bzw. 1 (for CIFX 50E-RE\ET) on, the **Rotary Switch Slot Number (Card ID)** is provided.

5.1.2 CIFX 50-DP, CIFX 50E-DP

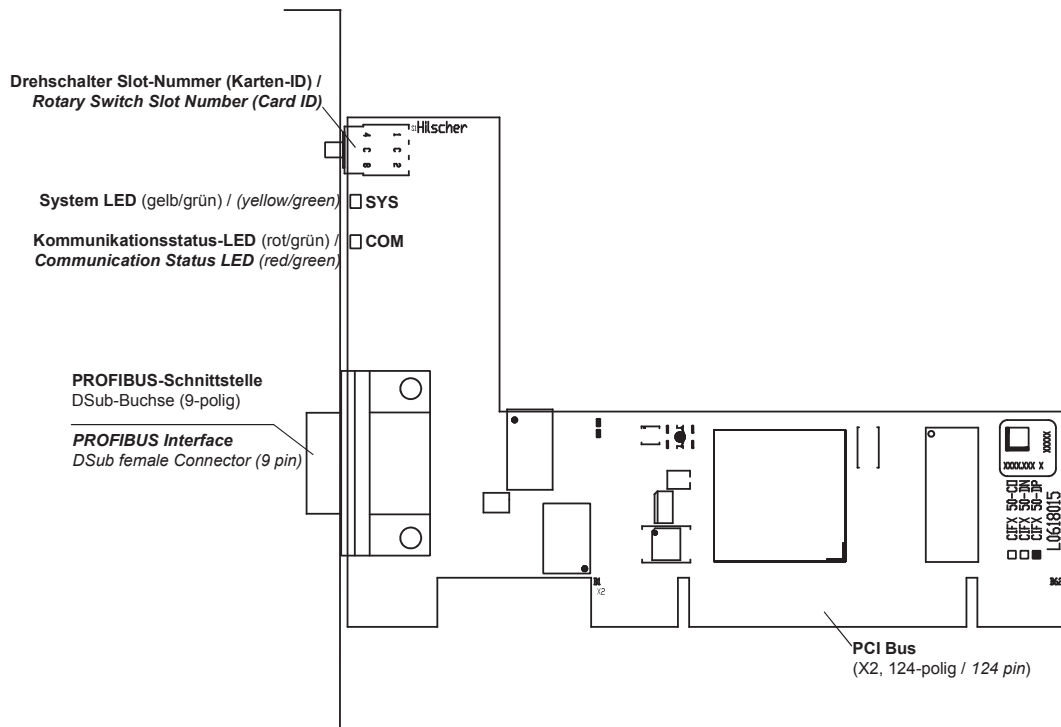

Figure 5: CIFX 50-DP (hardware revision 5)*

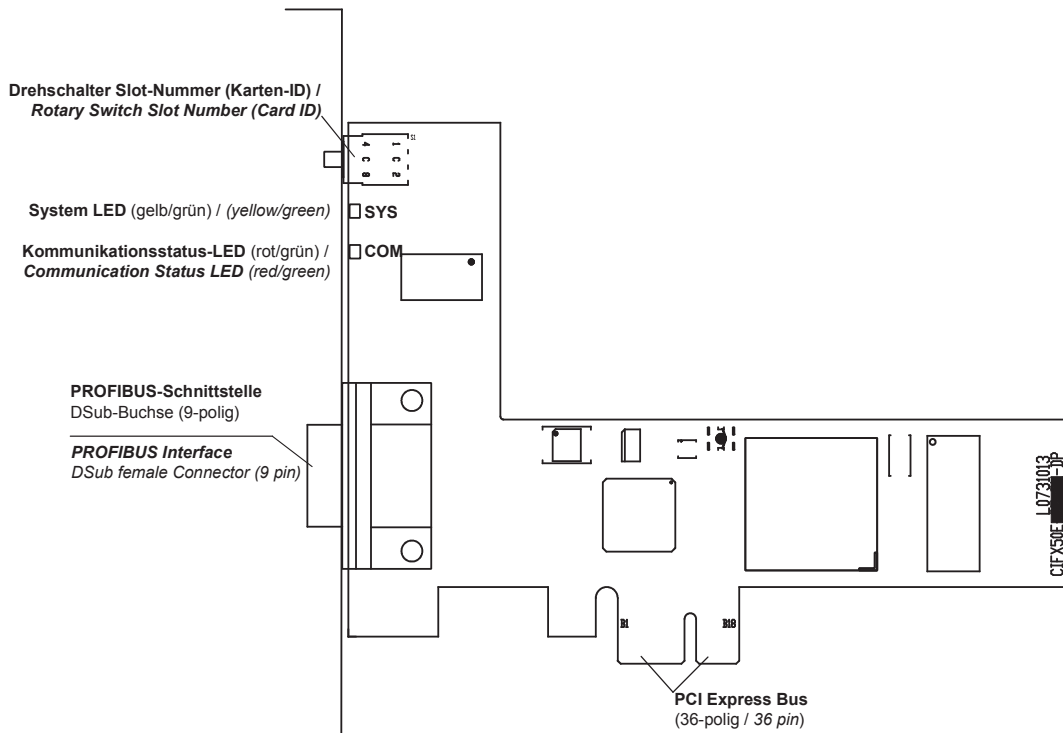

Figure 6: CIFX 50E-DP (hardware revision 5)*



*Device drawings of earlier device revisions without rotary switch slot number (card ID) or with two COM LEDs are included in the user manual for PC cards cifX fieldbus up to manual rev. 23.

The figure below shows the front plate of the PC cards CIFX 50-DP or CIFX 50E-DP:

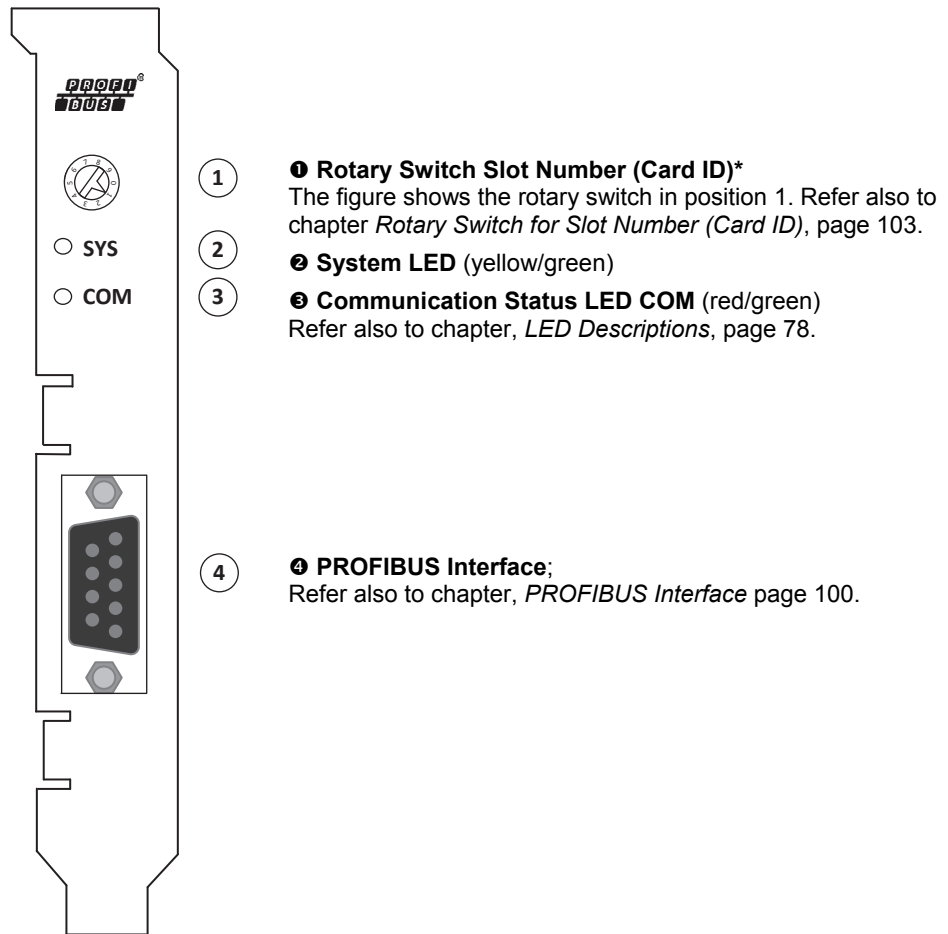
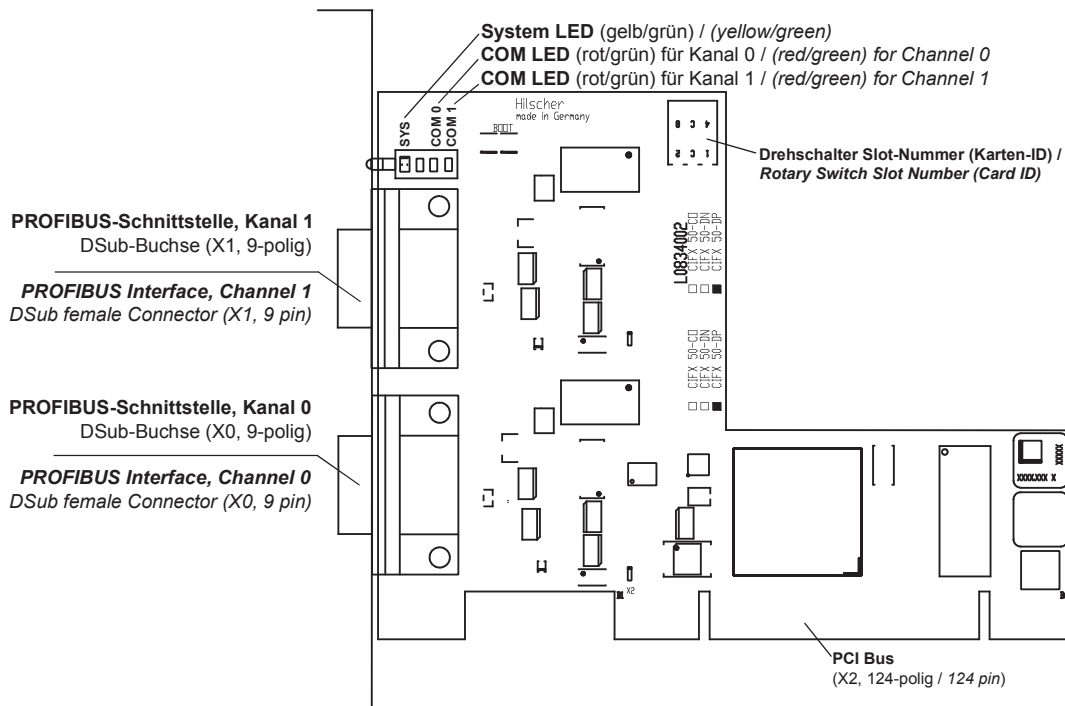

Figure 7: Front Plate CIFX 50-DP or CIFX 50E-DP

*From hardware revision 5 (for CIFX 50-DP or CIFX 50E-DP) on, the **Rotary Switch Slot Number (Card ID)** is provided.

5.1.3 CIFX 50-2DP



A Device drawing of the earlier device revision without rotary switch slot number (card ID) is included in the user manual rev. 37.

Figure 8: CIFX 50-2DP (Hardware Revision 3)

The figure below shows the front plate of the PC cards CIFX 50-2DP:

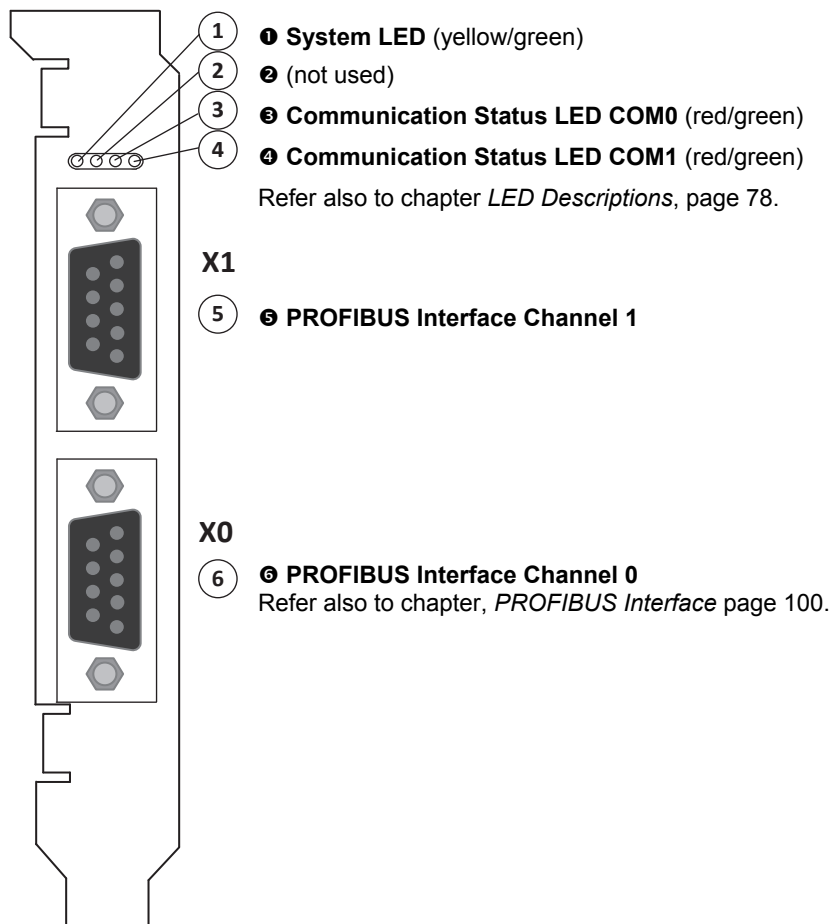

Figure 9: Front Plate CIFX 50-2DP

5.1.4 CIFX 50-2DP\CO

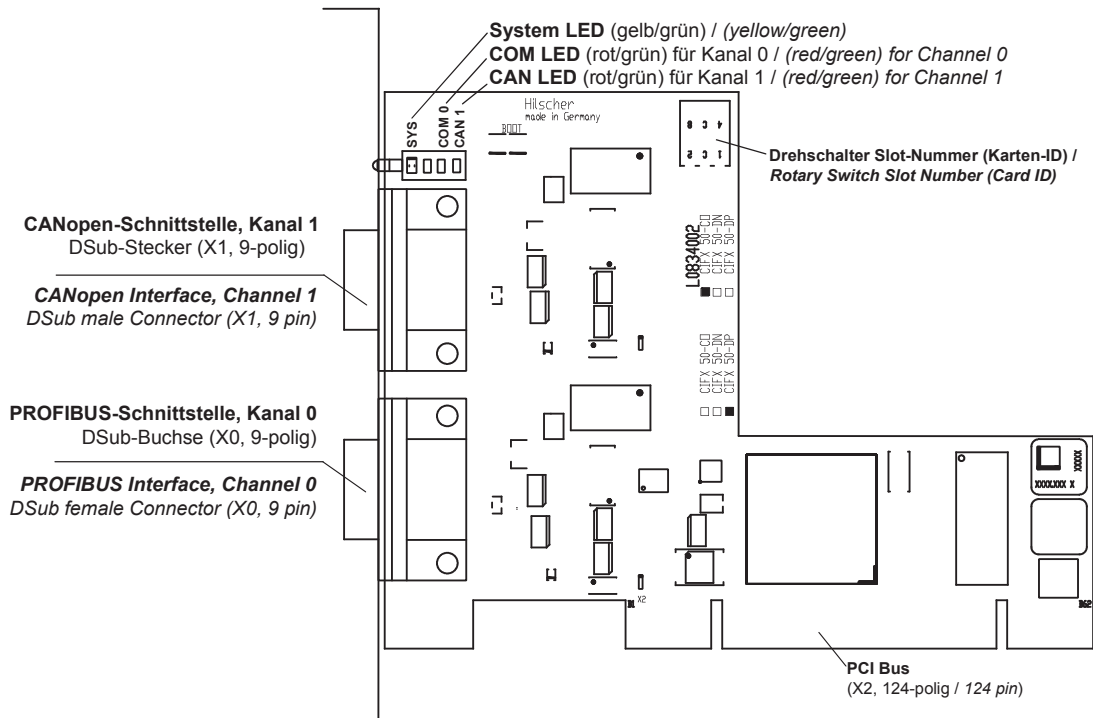

Figure 10: CIFX 50-2DP\CO (Hardware Revision 2)

The figure below shows the front plate of the PC cards CIFX 50-2DP\CO:

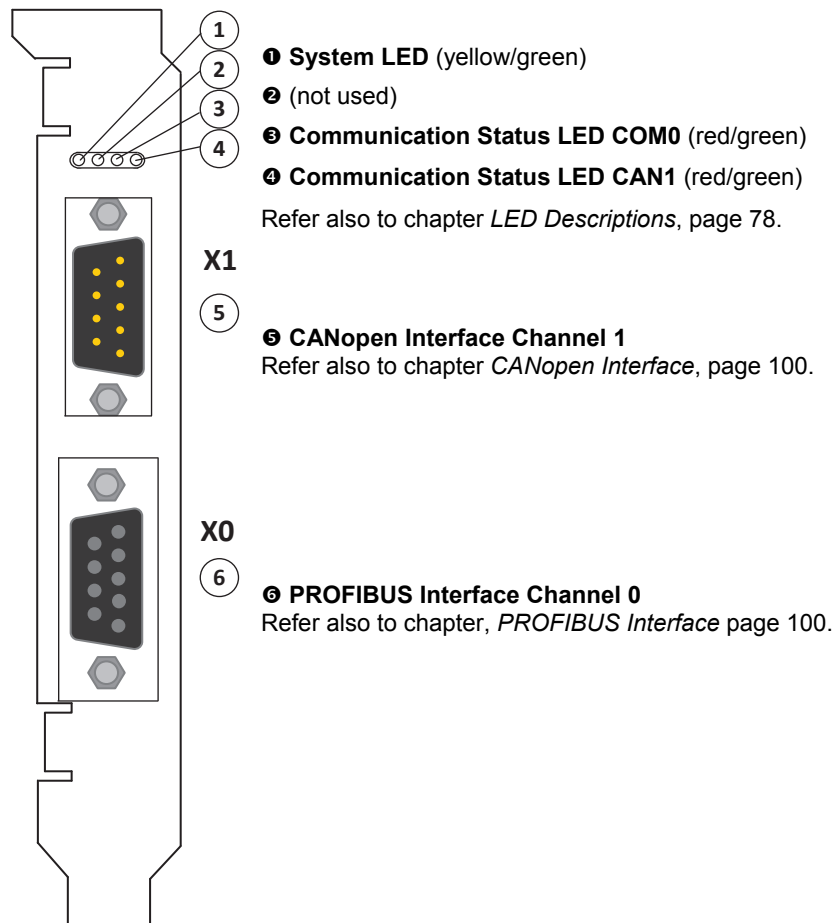

Figure 11: Front Plate CIFX 50-2DP\CO

5.1.5 CIFX 50-2DP\DN

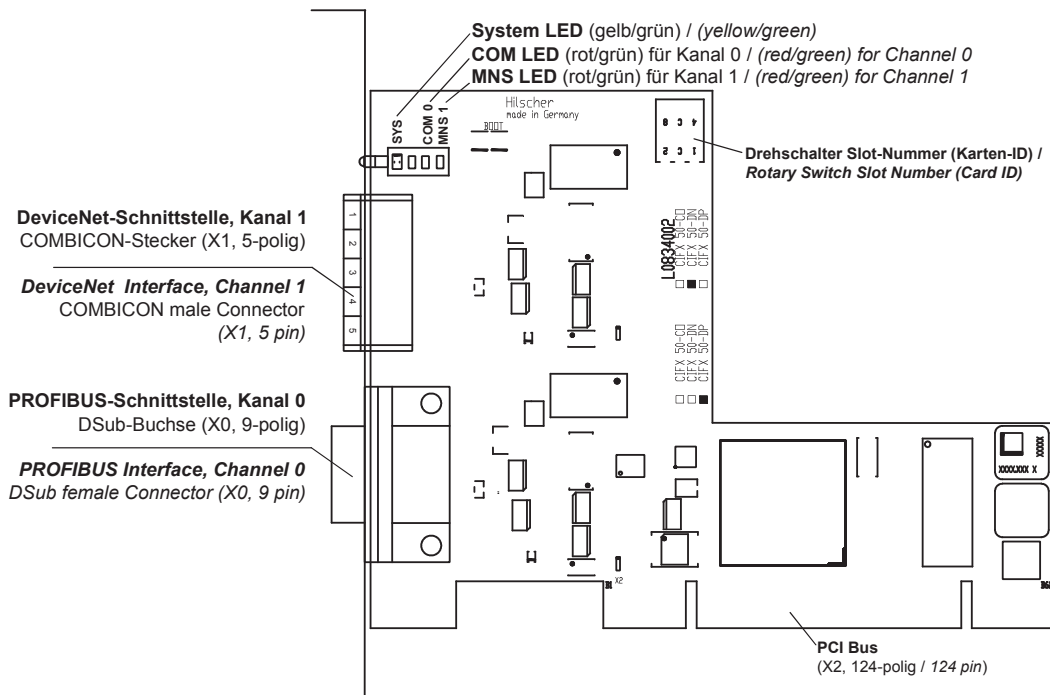

Figure 12: CIFX 50-2DP\DN (Hardware Revision 1)

The figure below shows the front plate of the PC cards CIFX 50-2DP\DN:

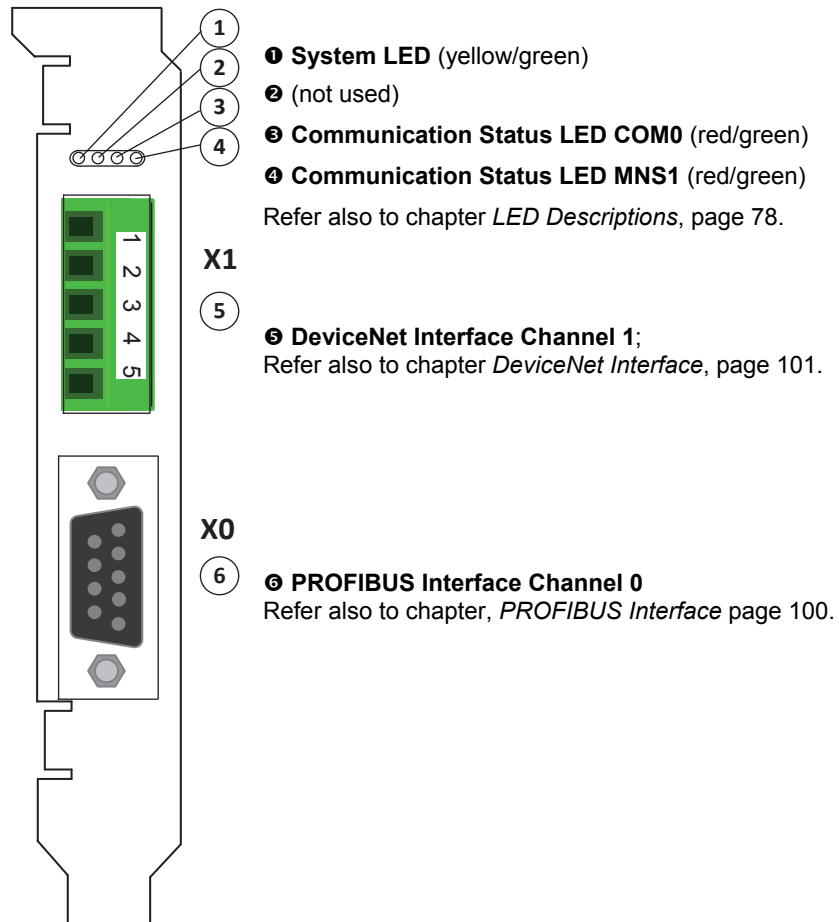

Figure 13: Front Plate CIFX 50-2DP\DN

5.1.6 CIFX 50-CO, CIFX 50E-CO

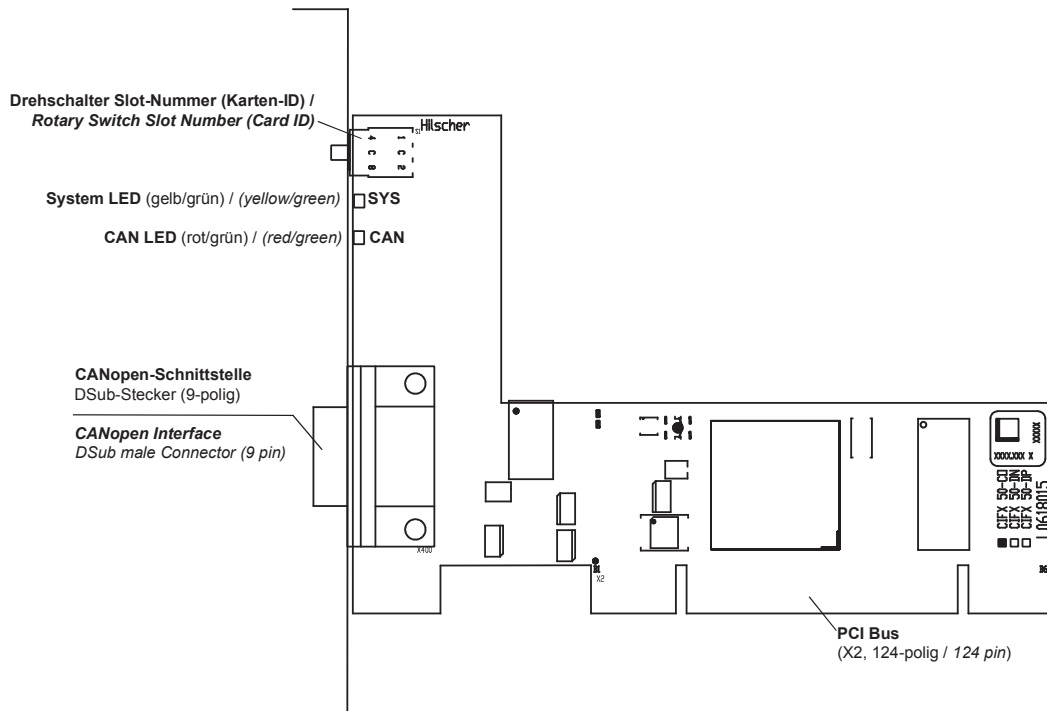

Figure 14: CIFX 50-CO (hardware revision 5)

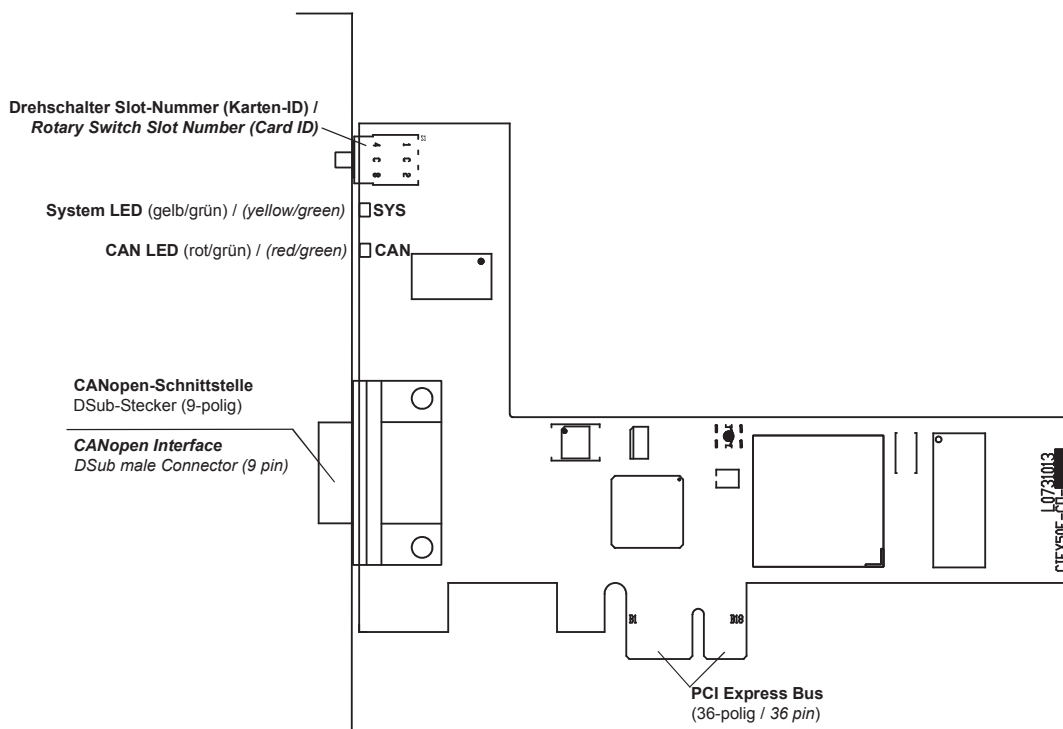

Figure 15: CIFX 50E-CO (from hardware revision 4)



Device drawings of earlier device revisions without rotary switch slot number (card ID) or with two COM LEDs are included in the user manual for PC cards cifX fieldbus up to manual rev. 23.

The figure below shows the front plate of the PC cards CIFX 50-CO or CIFX 50E-CO:

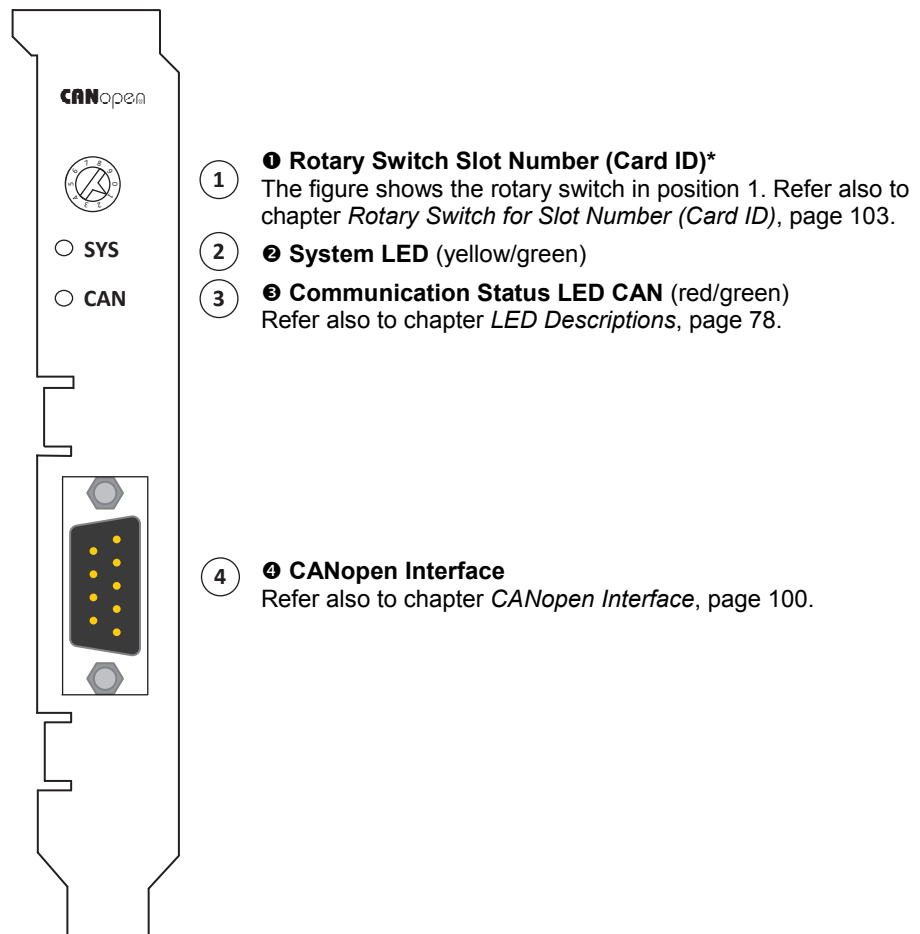

Figure 16: Front Plate for CIFX 50-CO or CIFX 50E-CO

*From hardware revision 5 (for CIFX 50-CO or CIFX 50E-CO) on, the **Rotary Switch Slot Number (Card ID)** is provided.

5.1.7 CIFX 50-2CO

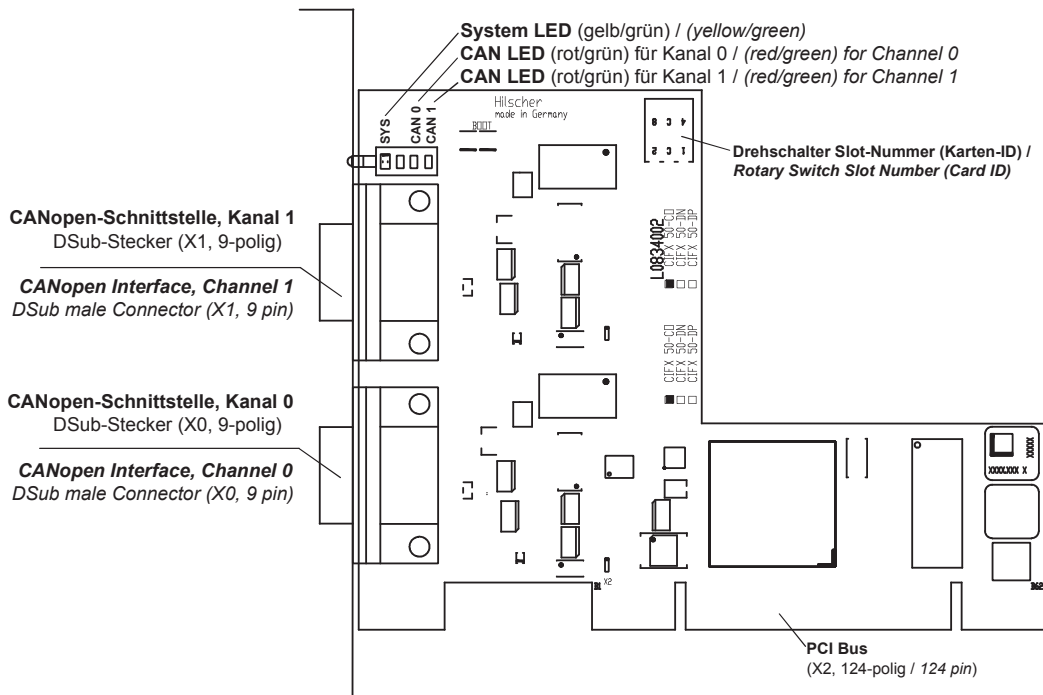

Figure 17: CIFX 50-2CO (Hardware Revision 2)

The figure below shows the front plate of the PC cards CIFX 50-2CO:

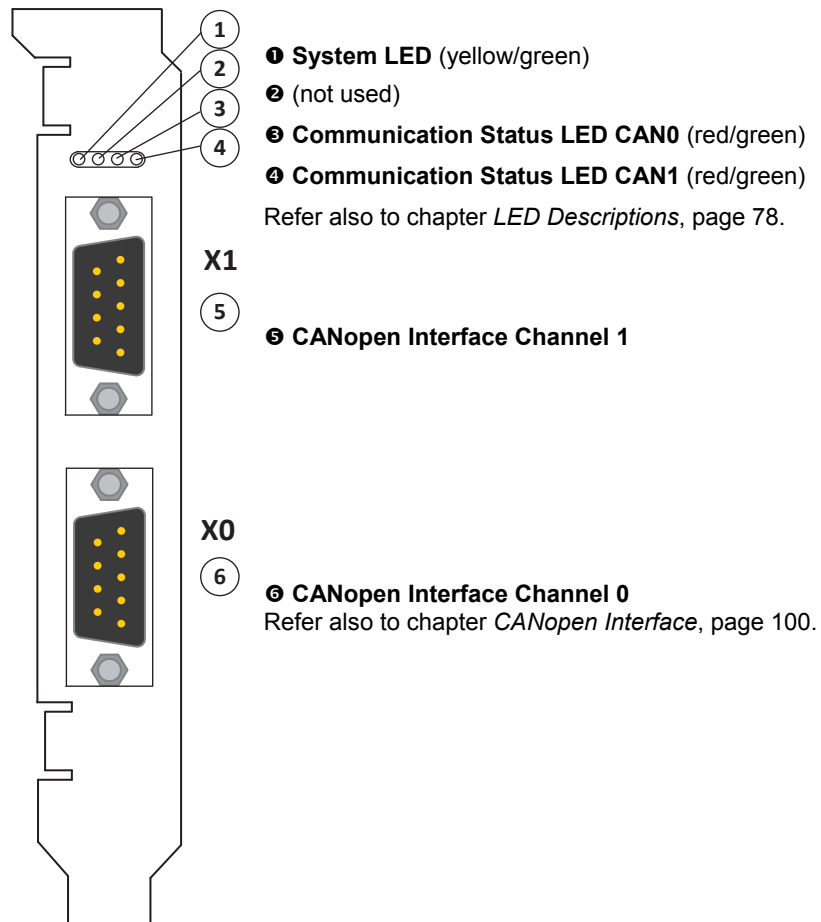

Figure 18: Front Plate CIFX 50-2CO

5.1.8 CIFX 50-2CO\DN

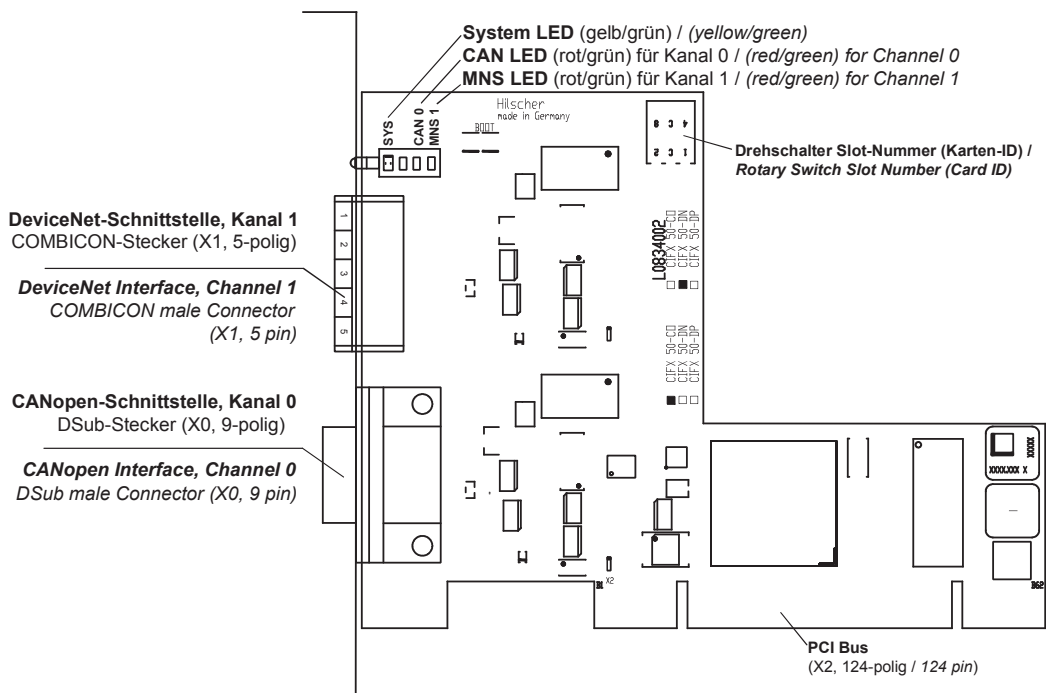

Figure 19: CIFX 50-2 CO\DN (Hardware Revision 1)

The figure below shows the front plate of the PC cards CIFX 50-2CO\DN:

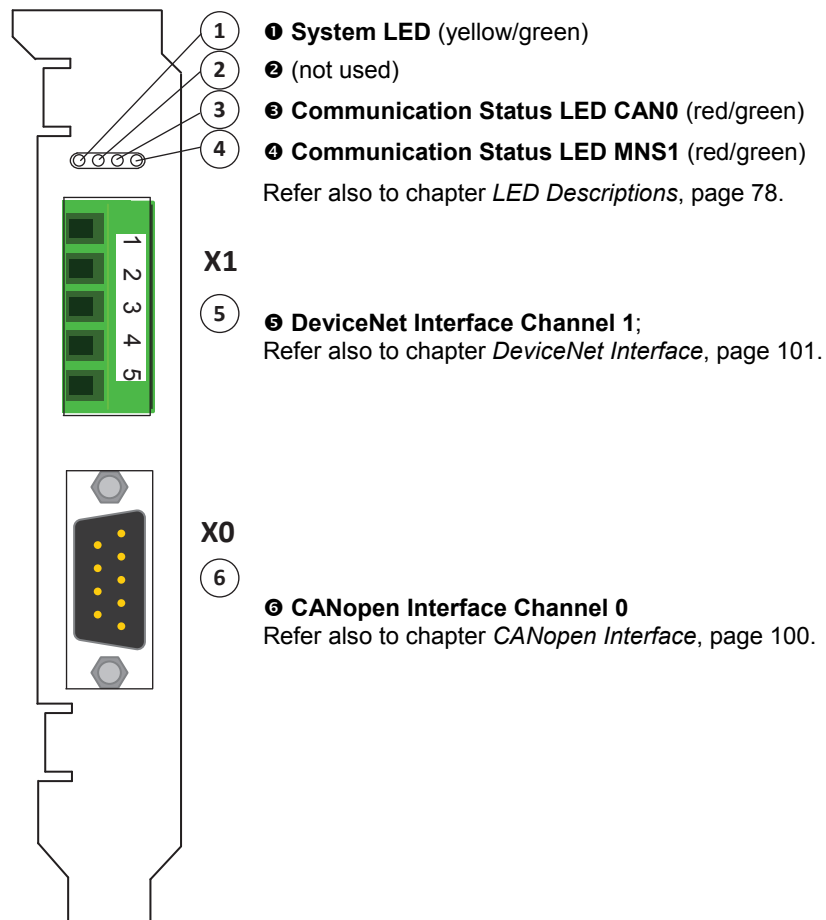

Figure 20: Front Plate CIFX 50-2CO\DN

5.1.9 CIFX 50-DN, CIFX 50E-DN

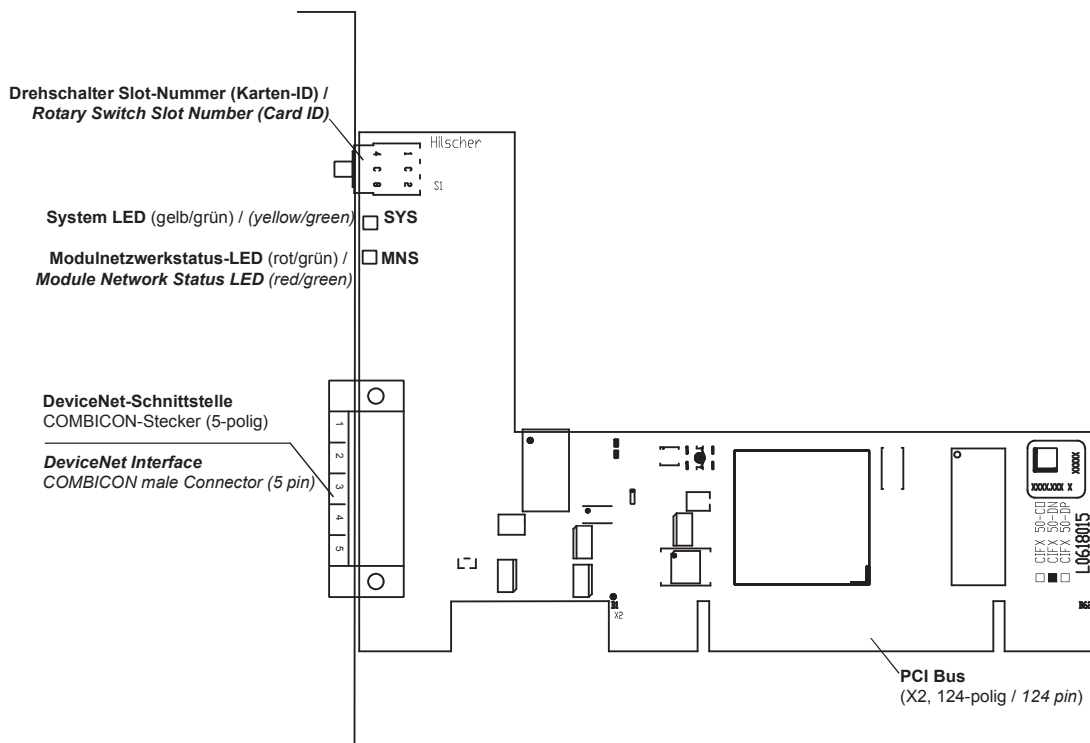

Figure 21: CIFX 50-DN (hardware revision 5)

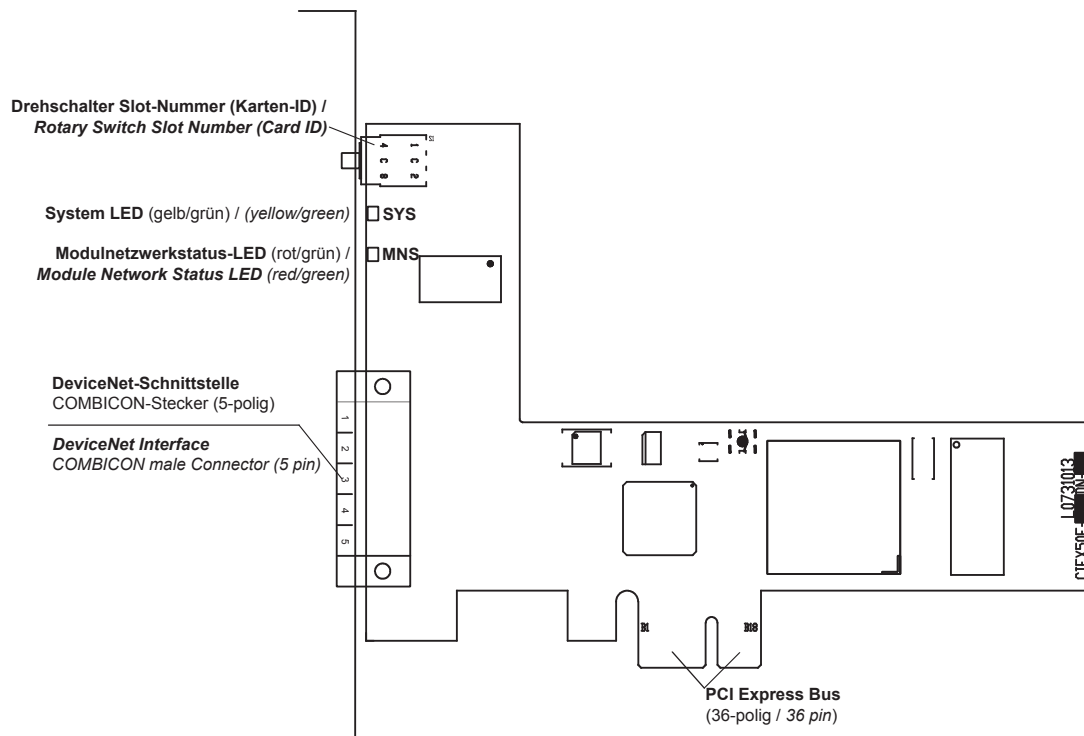

Figure 22: CIFX 50E-DN (from hardware revision 4)



Device drawings of earlier device revisions without rotary switch slot number (card ID) are included in the user manual for PC cards cifX fieldbus up to manual rev. 23.

The figure below shows the front plate of the PC cards CIFX 50-DN or CIFX 50E-DN:

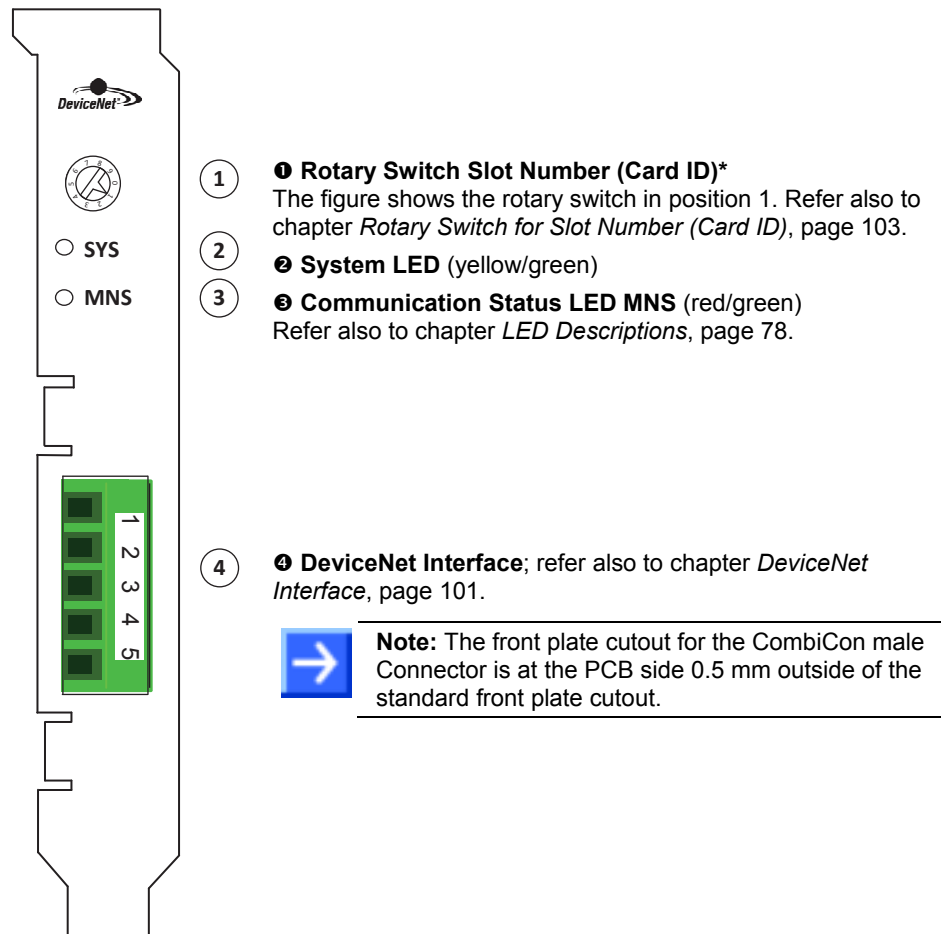

Figure 23: Front Plate CIFX 50-DN or CIFX 50E-DN

*From hardware revision 5 (for CIFX 50-DN or CIFX 50E-DN on, the **Rotary Switch Slot Number (Card ID)** is provided.

5.1.10 CIFX 50-2DN

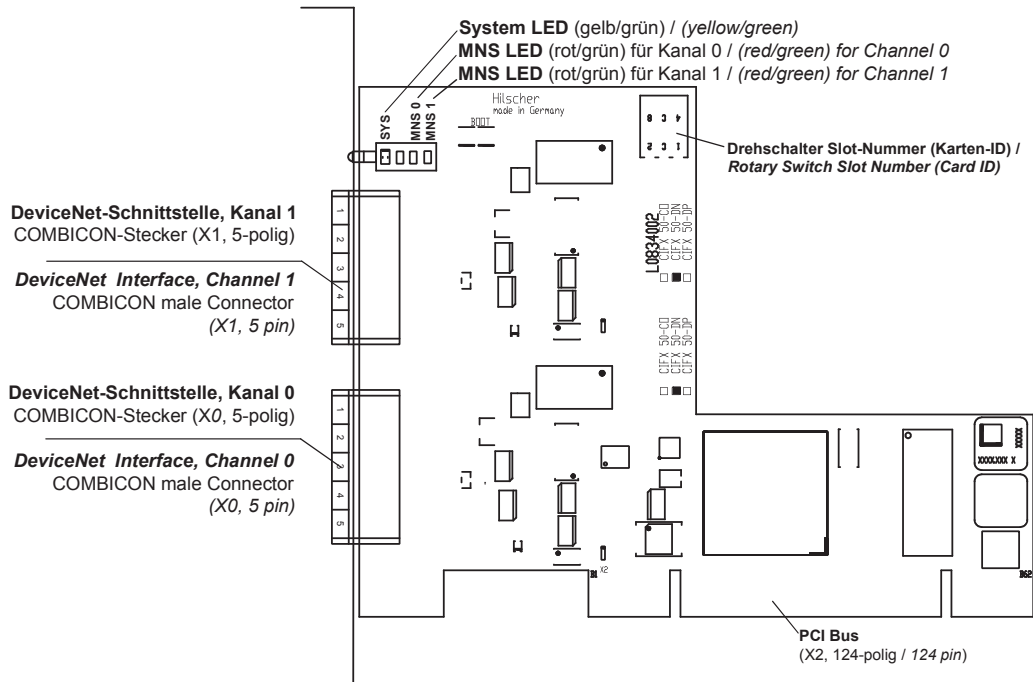

Figure 24: CIFX 50-2DN (Hardware Revision 2)

The figure below shows the front plate of the PC cards CIFX 50-2DN:

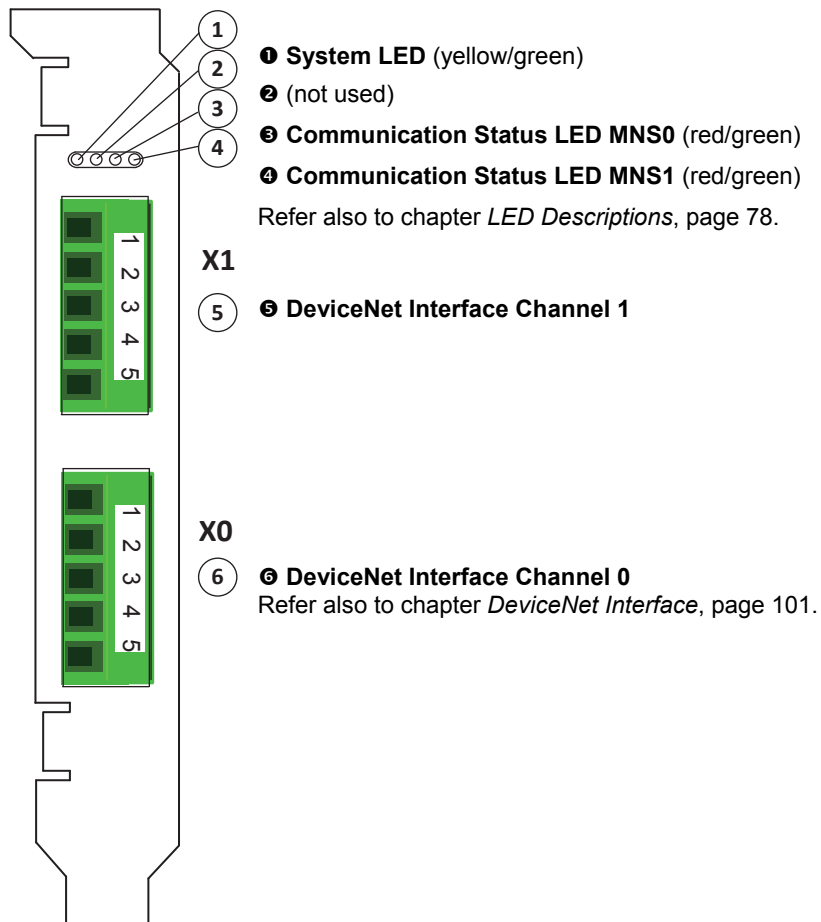

Figure 25: Front Plate CIFX 50-2DN

5.1.11 CIFX 50-2ASM, CIFX 50E-2ASM

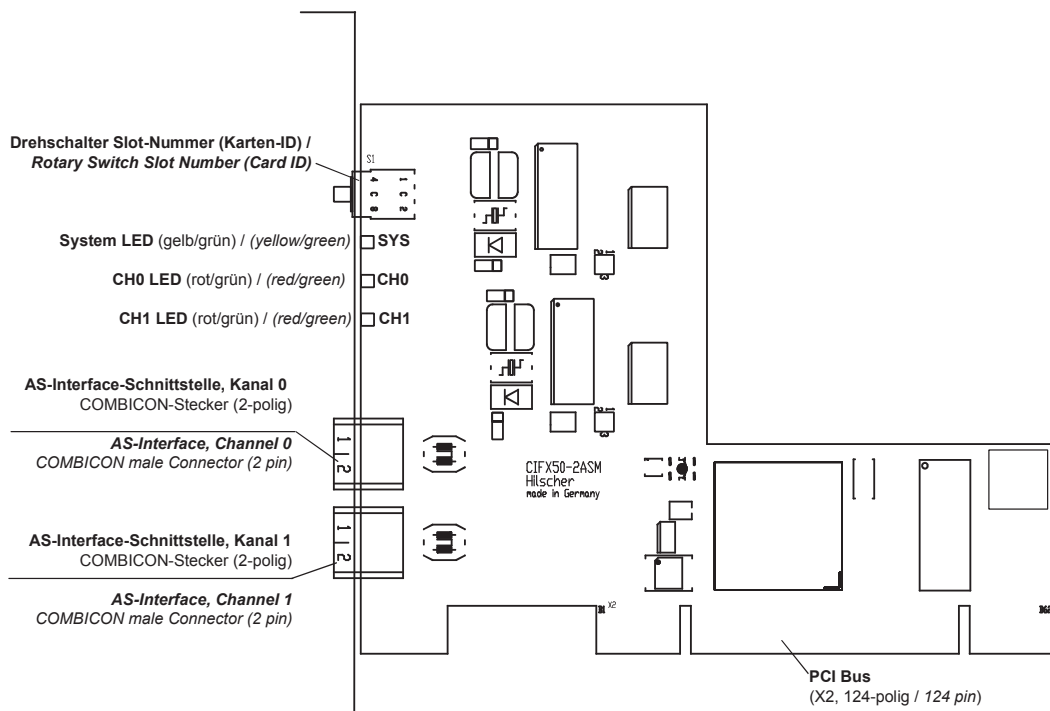

Figure 26: CIFX 50-2ASM (hardware revision 2)

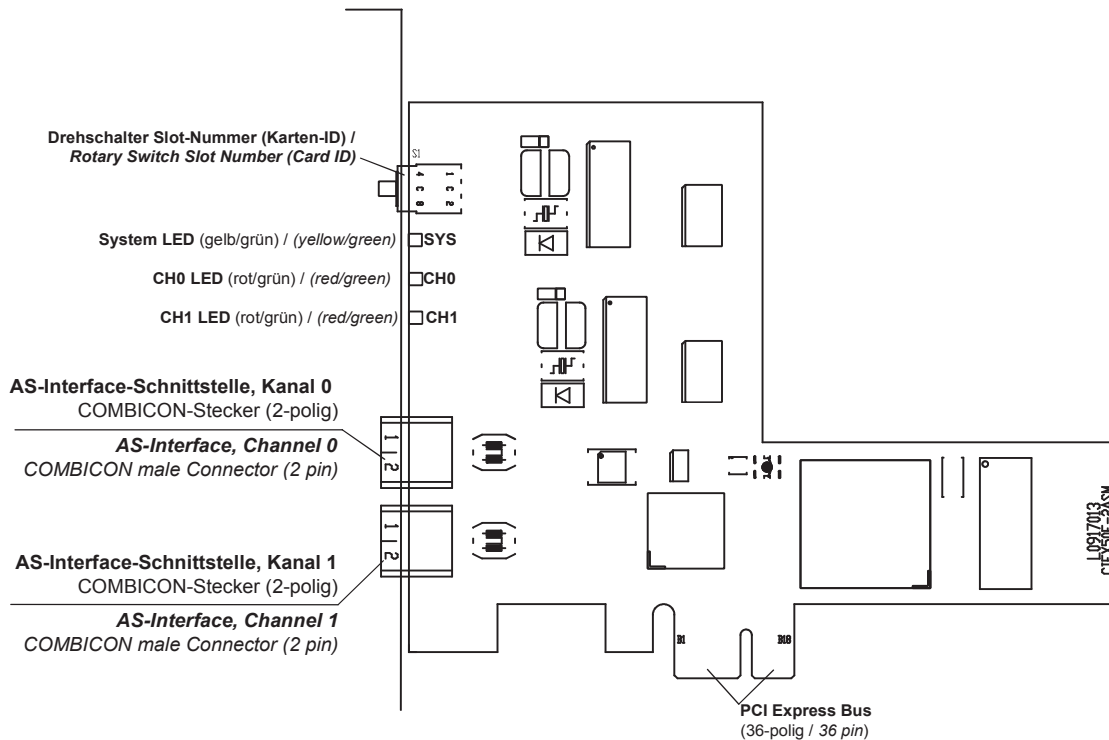

Figure 27: CIFX 50E-2ASM (from hardware revision 2)



Device drawings of earlier device revisions without rotary switch slot number (card ID) are included in the user manual for PC cards cifX fieldbus up to manual rev. 23.

The figure below shows the front plate of the PC card CIFX 50-2ASM:

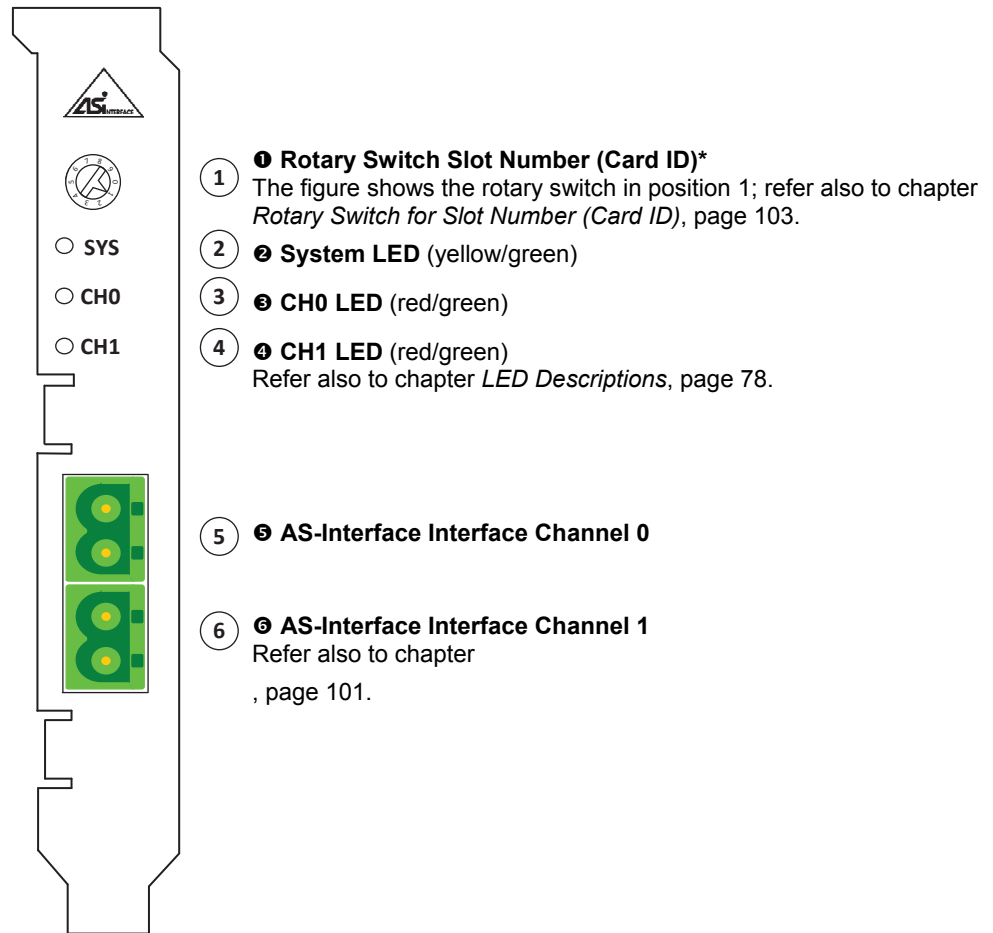

Figure 28: Front Plate CIFX 50-2ASM

*From hardware revision 2 on, the **Rotary Switch Slot Number (Card ID)** is provided.

5.1.12 CIFX 50-CC, CIFX 50E-CC

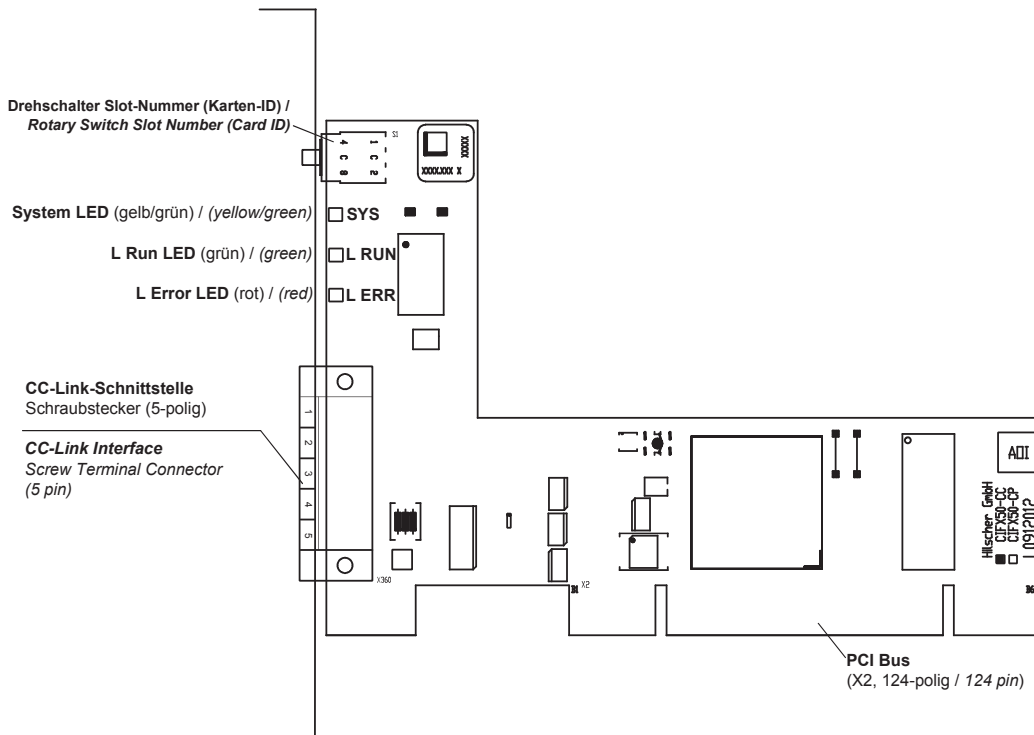

Figure 29: CIFX 50-CC (hardware revision 2)*

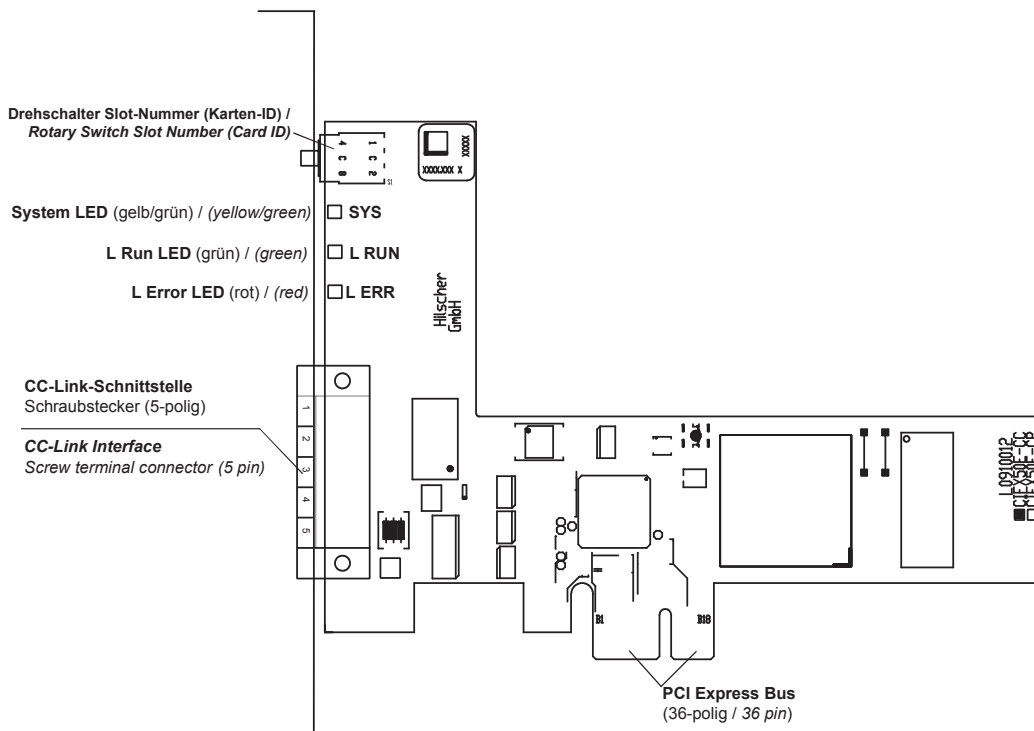

Figure 30: CIFX 50E-CC (hardware revision 4)*



Device drawings of earlier device revisions without rotary switch slot number (card ID) are included in the user manual for PC cards cifX fieldbus up to manual rev. 23.



Note: *The front plate cutout for the screw terminal connector is at the PCB side 0.5 mm outside of the standard front plate cutout.

The figure below shows the front plate of the PC cards CIFX 50-CC or CIFX 50E-CC:

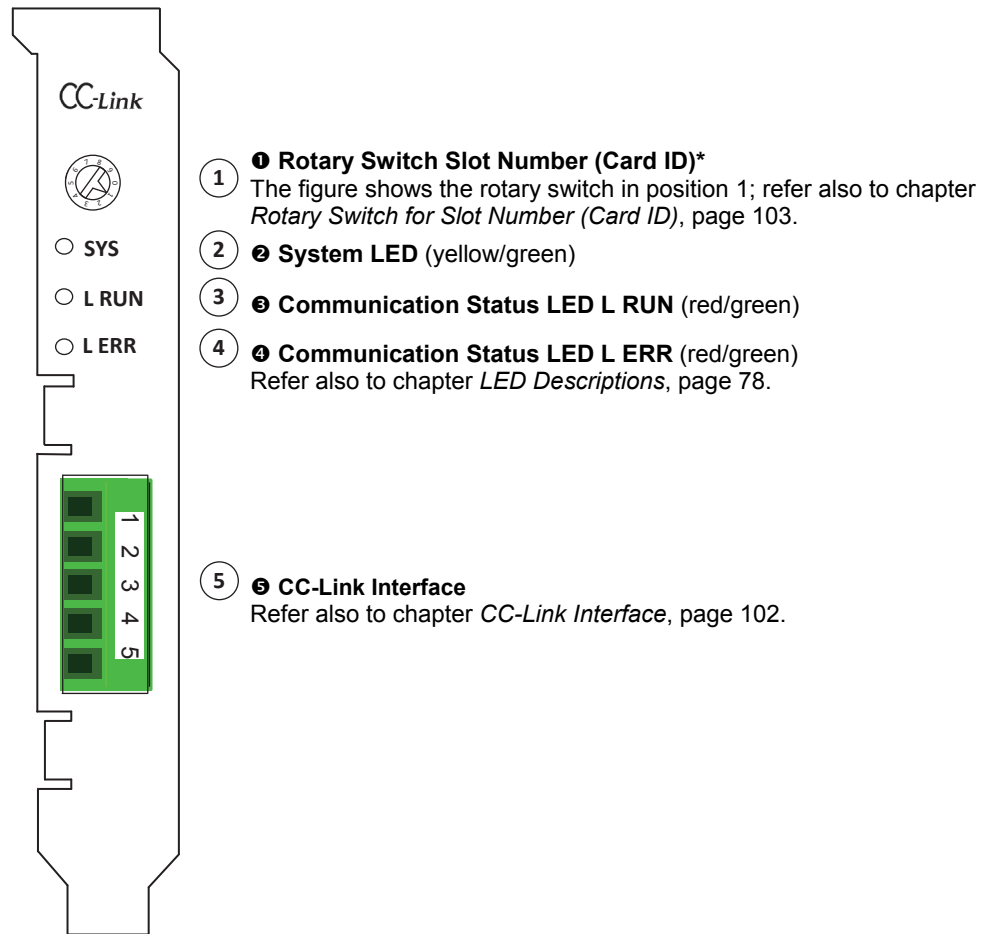

Figure 31: Front Plate CIFX 50-CC or CIFX 50E-CC

*From hardware revision 2 (for CIFX 50-CC) on or 3 (for CIFX 50E-CC), the **Rotary Switch Slot Number (Card ID)** is provided.

5.2 PC Cards cifX Low Profile PCI Express

5.2.1 CIFX 70E-RE, CIFX 70E-RE\MR

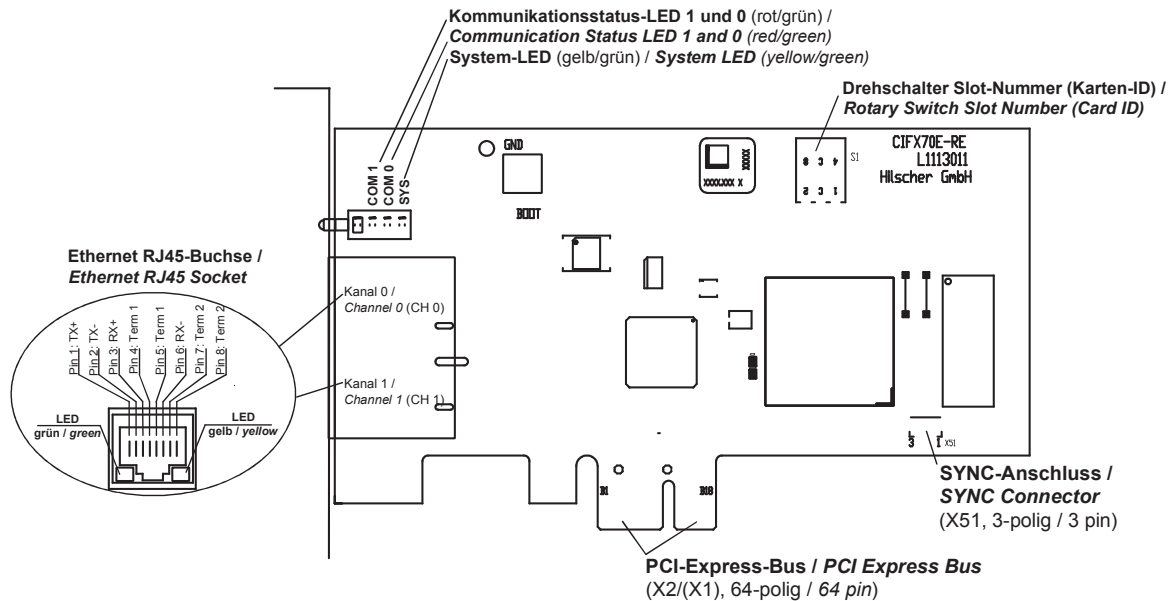

Figure 32: CIFX 70E-RE* (Hardware revision 1)

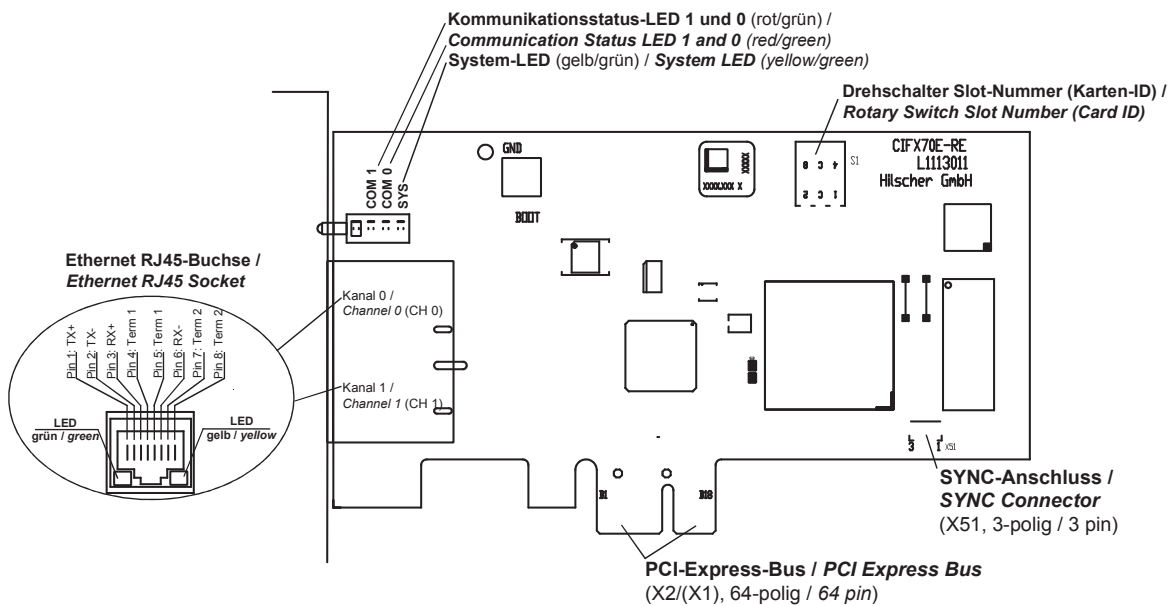

Figure 33: CIFX 70E-RE\MR* (Hardware revision 1)



Note: *Device supports Auto Crossover Function. Note also: With loaded EtherCAT Master firmware only the RJ45 channel 0 can be used, channel 1 is deactivated. Beginning with the EtherCAT Master firmware version 3 channel 1 can be reactivated if redundancy is activated. For Open Modbus/TCP with V2.3.4.0 and higher both RJ45 channels can be used.



. About **Rotary Switch for Slot Number (Card ID)** refer to section *Rotary Switch for Slot Number (Card ID)*, on page 103.

For the **SYNC** pin assignment of the SYNC Connector refer to section *Pin Assignment SYNC Connector, X51 (CIFX 50 50E 70E)* on page 105.

The figure below shows the front plate of the PC card CIFX 70E-RE or , CIFX 70E-RE\MR:

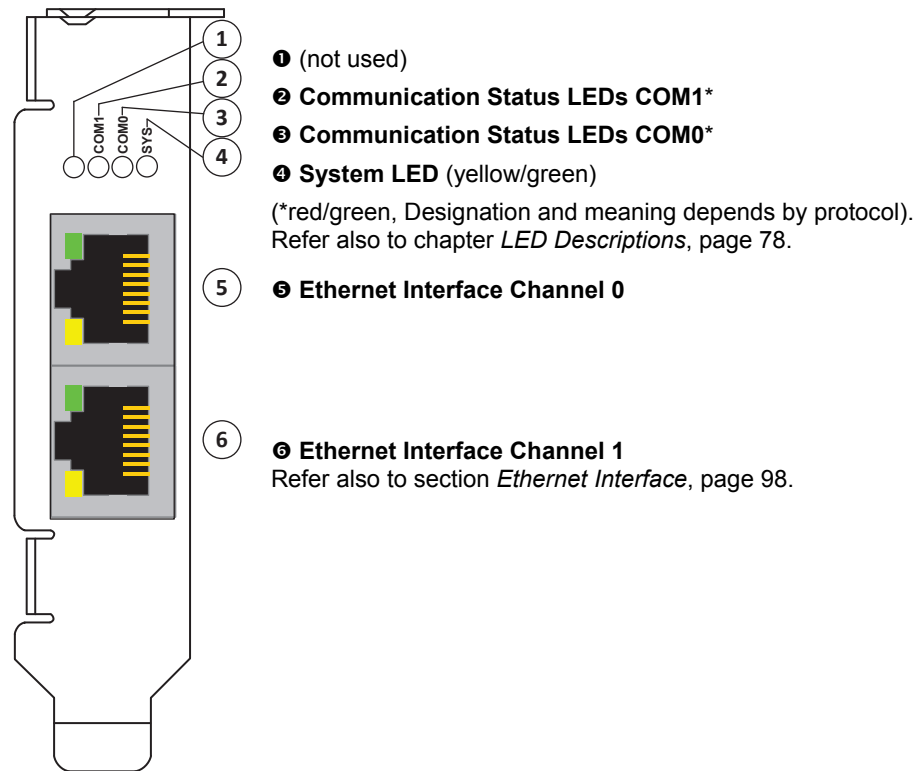

Figure 34: Front Plate for CIFX 70E-RE, CIFX 70E-RE\MR

5.2.2 CIFX 100EH-RE\CUBE

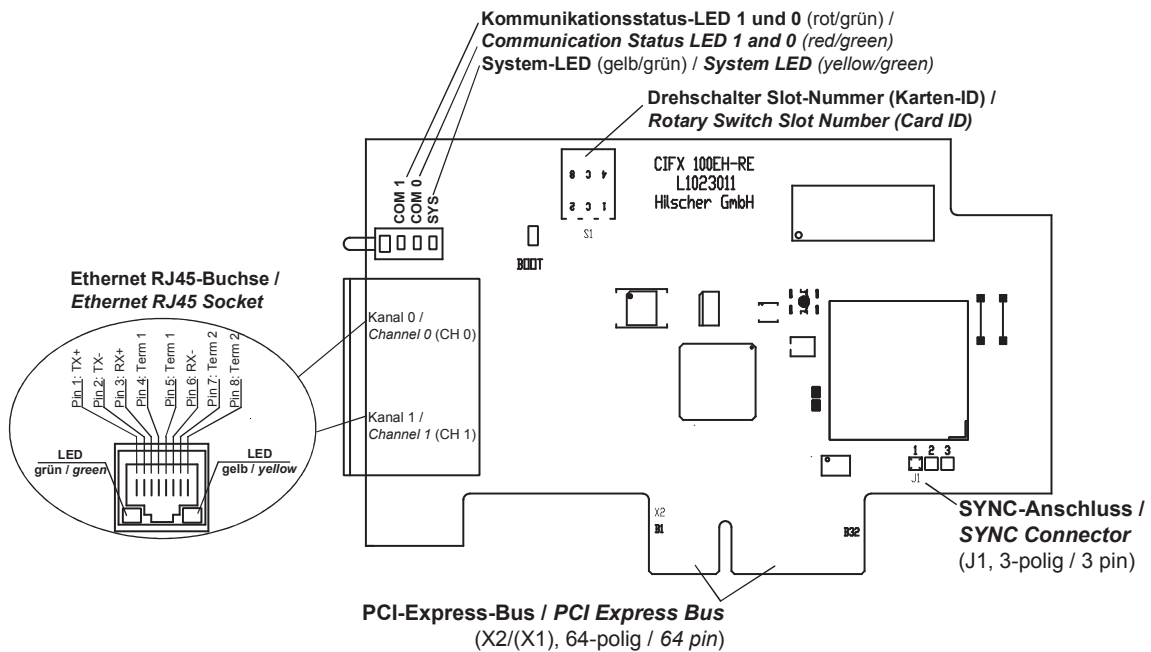
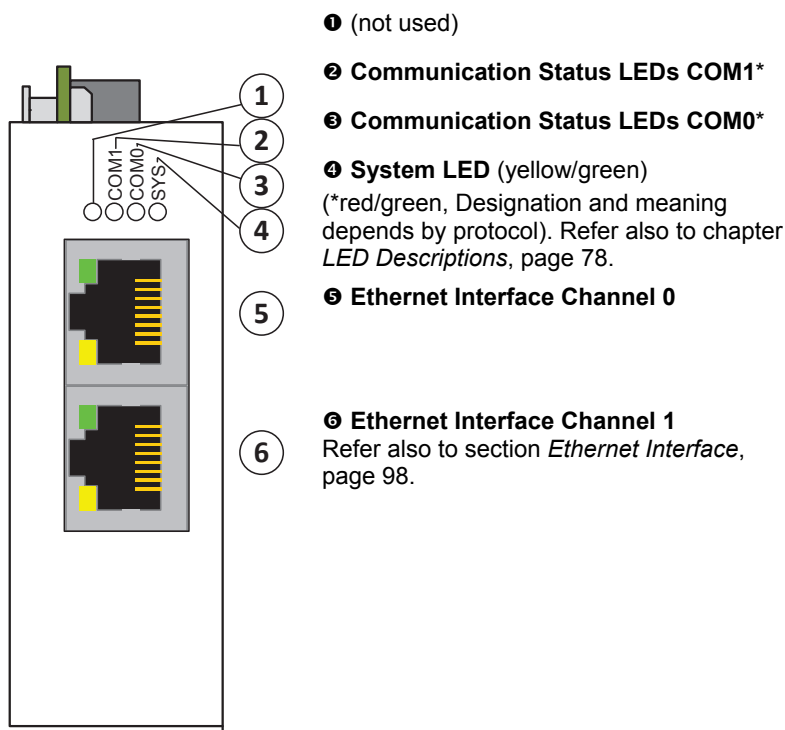

Figure 35: CIFX 100EH-RE\CUBE*

The figure below shows the front plate of the PC card CIFX 100EH-RE\CUBE:



Note: *Device supports Auto Crossover Function. Note also: With loaded EtherCAT Master firmware only the RJ45 channel 0 can be used, channel 1 is deactivated. Beginning with the EtherCAT Master firmware version 3 channel 1 can be reactivated if redundancy is activated. For Open Modbus/TCP with V2.3.4.0 and higher both RJ45 channels can be used.



About **Rotary Switch for Slot Number (Card ID)** refer to section *Rotary Switch for Slot Number (Card ID)*, on page 103.

For the pin assignment of the **PCI Express** bus X2(X1) see section *Pin Assignment for PCI Express Bus CIFX 100EH-RE\CUBE* on page 108.

For the **SYNC** pin assignment of the SYNC Connector refer to section *Pin Assignment SYNC Connector, J1 (CIFX 100EH)* on page 105.

Figure 36: Front Plate CIFX 100EH-RE\CUBE

5.2.3 CIFX 70E-DP, CIFX 70E-DP\MR

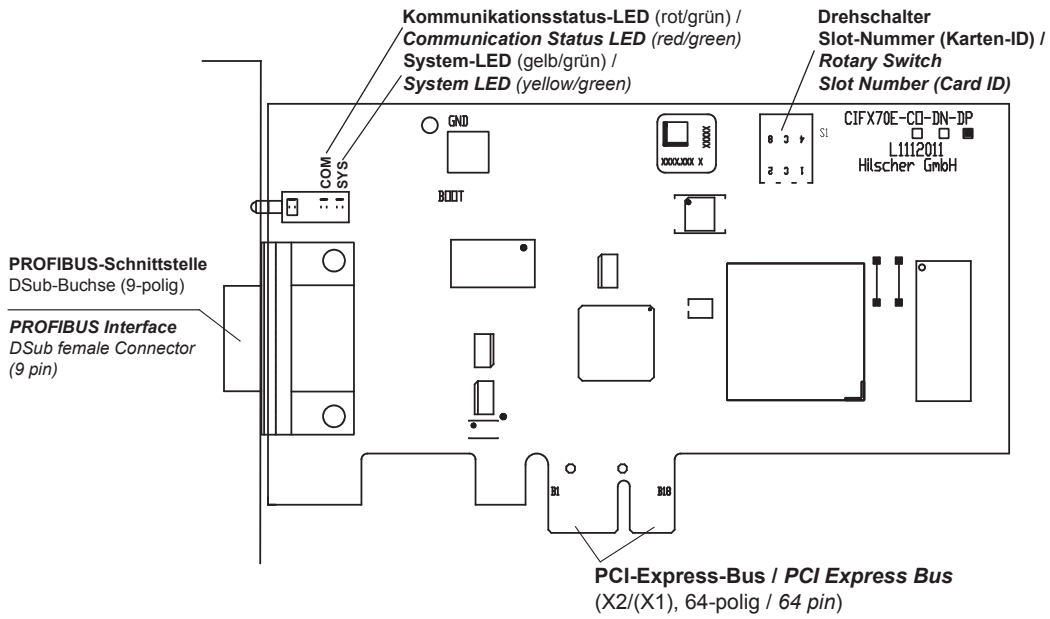

Figure 37: CIFX 70E-DP (Hardware revision 1)

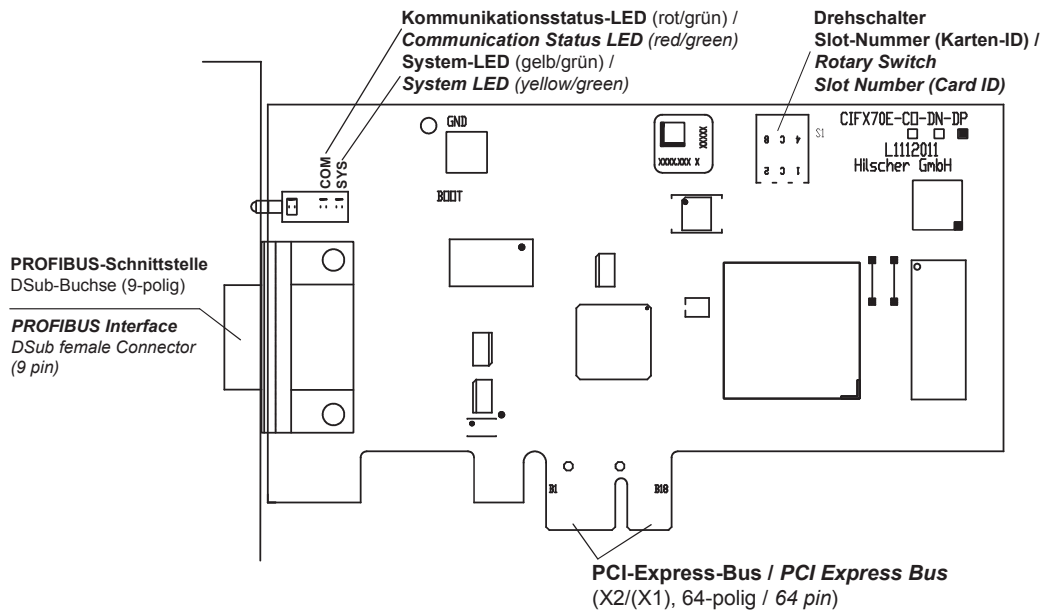

Figure 38: CIFX 70E-DP\MR (Hardware revision 1)



About **Rotary Switch for Slot Number (Card ID)** refer to section *Rotary Switch for Slot Number (Card ID)*, on page 103.

The figure below shows the front plate of the PC card CIFX 70E-DP or CIFX 70E-DP1MR:

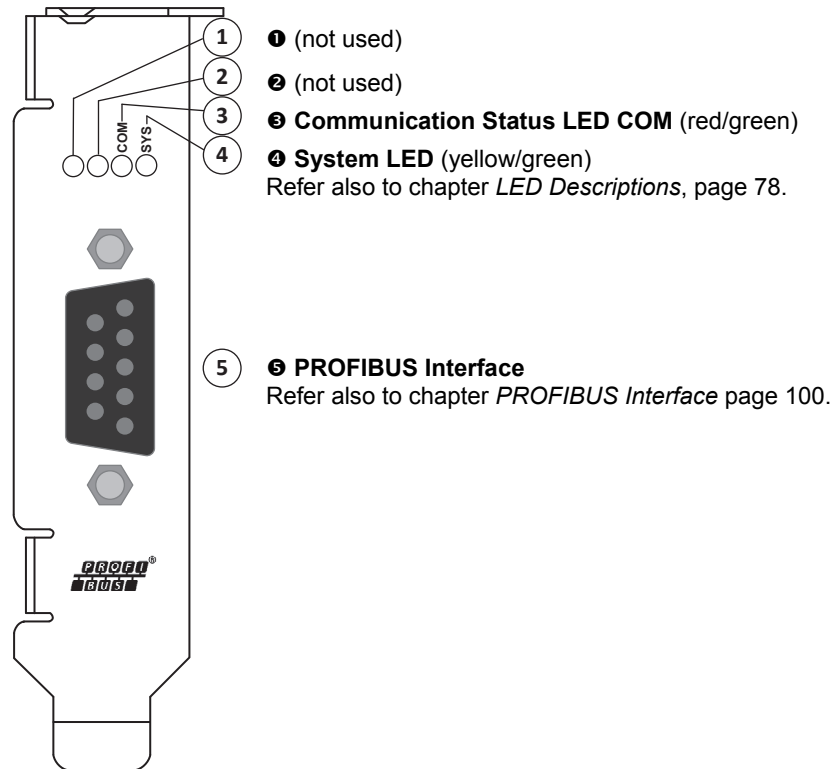

Figure 39: Front Plate CIFX 70E-DP, CIFX 70E-DP1MR

5.2.4 CIFX 70E-CO, CIFX 70E-CO\MR

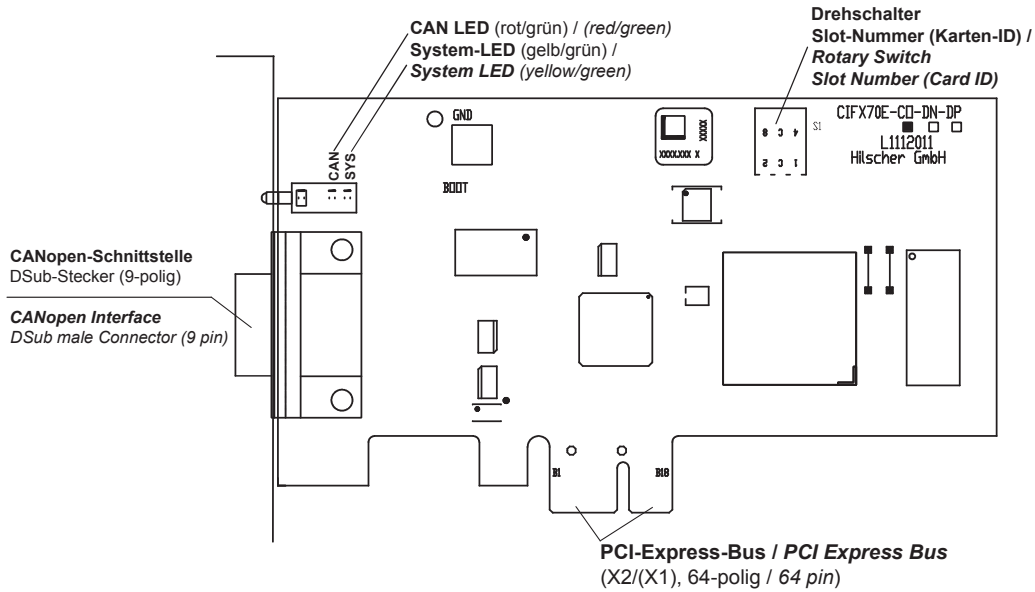

Figure 40: CIFX 70E-CO (Hardware revision 1)

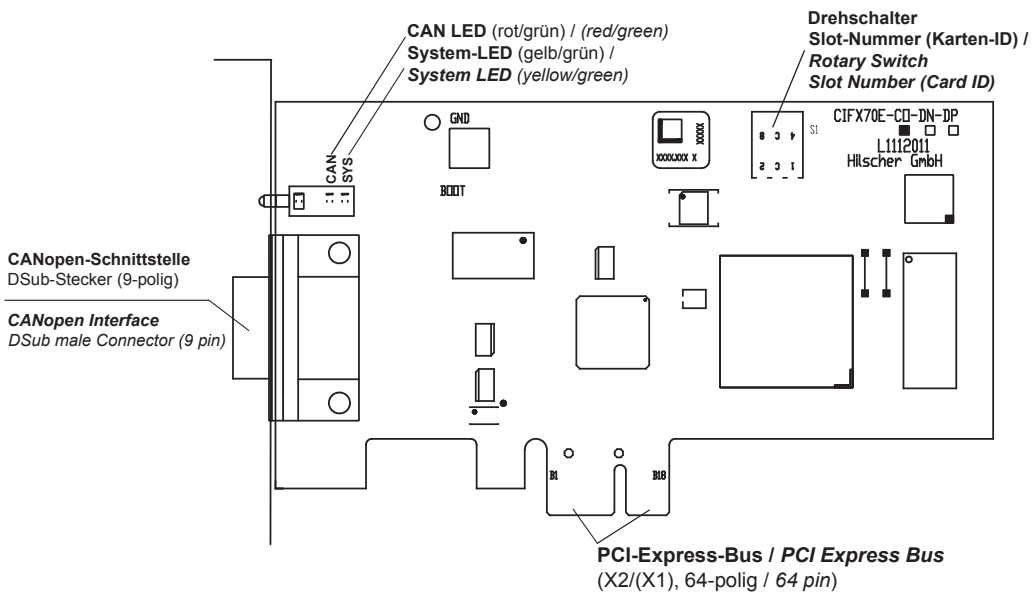

Figure 41: CIFX 70E-CO\MR (Hardware revision 1)



About **Rotary Switch for Slot Number (Card ID)** refer to section *Rotary Switch for Slot Number (Card ID)*, on page 103.

The figure below shows the front plate of the PC card CIFX 70E-CO or CIFX 70E-COMR:

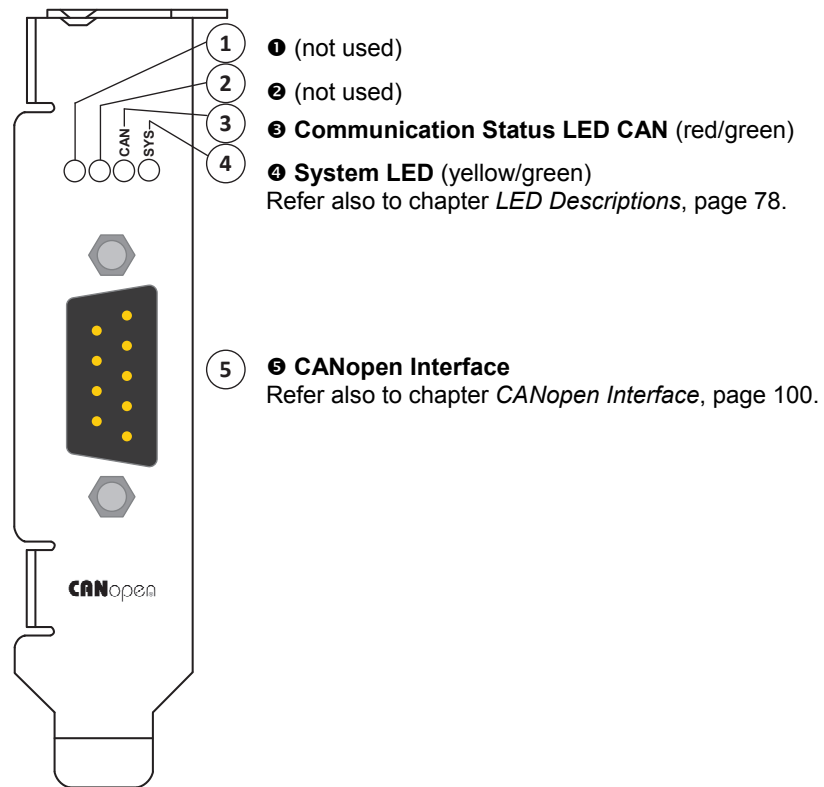

Figure 42: Front Plate CIFX 70E-CO, CIFX 70E-COMR

5.2.5 CIFX 70E-DN, CIFX 70E-DN\MR

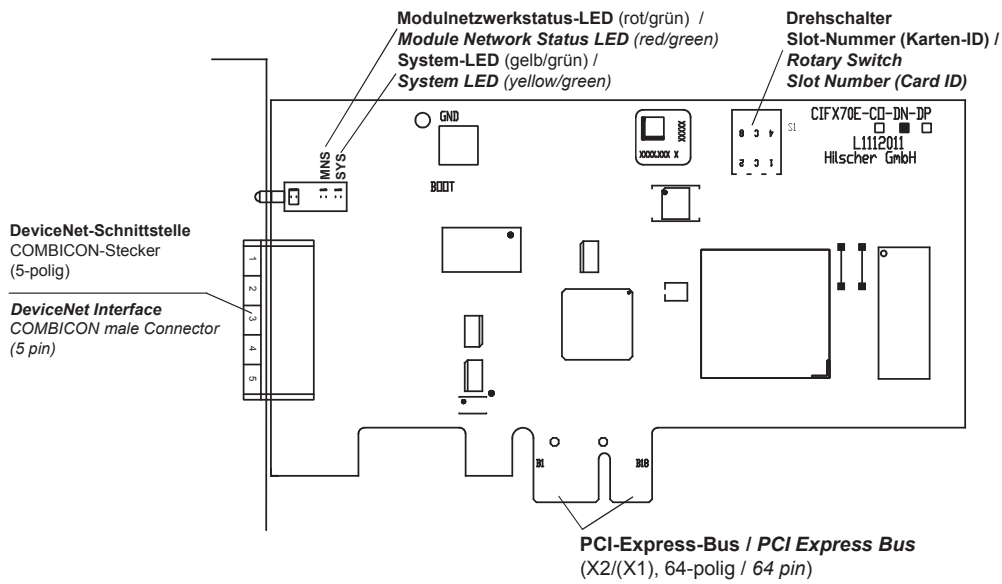

Figure 43: CIFX 70E-DN (Hardware revision 1)

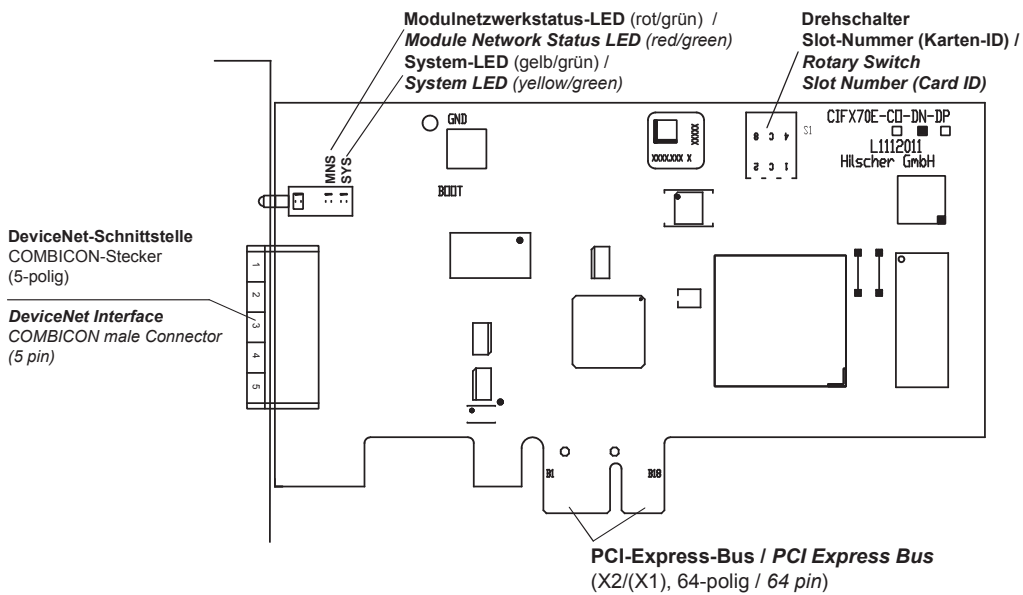

Figure 44: CIFX 70E-DNMR (Hardware revision 1)



About **Rotary Switch for Slot Number (Card ID)** refer to section *Rotary Switch for Slot Number (Card ID)*, on page 103.

The figure below shows the front plate of the PC card CIFX 70E-DN or CIFX 70E-DNMR:

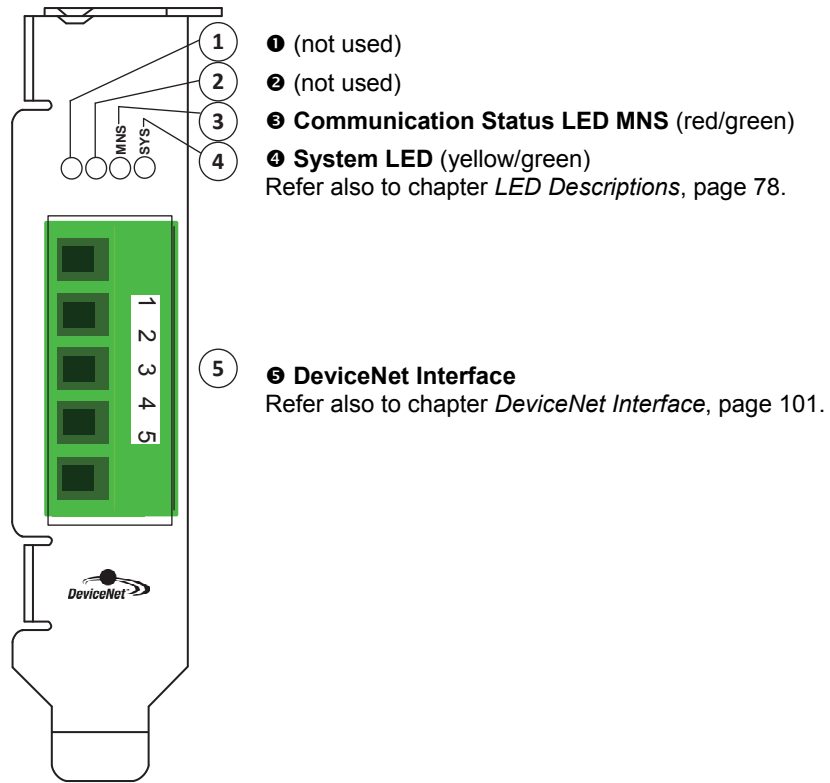

Figure 45: Front Plate CIFX 70E-DN, CIFX 70E-DNMR

6 Hardware Installation and Uninstalling

To install / uninstall the PC Cards cifX the PC Cards cifX **PCI Express PCI**

- CIFX 50-RE, CIFX 50-RE\ET,
- CIFX 50-DP, CIFX 50-2DP,
- CIFX 50-2DP\CO, CIFX 50-2DP\DN,
- CIFX 50-CO, CIFX 50-2CO,
- CIFX 50-2CO\DN,
- CIFX 50-DN, CIFX 50-2DN,
- CIFX 50-2ASM,
- CIFX 50-CC
- CIFX 50E-RE, CIFX 50E-RE\ET,
- CIFX 50E-DP,
- CIFX 50E-CO,
- CIFX 50E-DN,
- CIFX 50E-2ASM,
- CIFX 50E-CC

and **Low Profile PCI Express**

- CIFX 70E-RE, CIFX 70E-RE\MR,
- CIFX 100EH-RE\CUBE
- CIFX 70E-DP, CIFX 70E-DP\MR,
- CIFX 70E-CO, CIFX 70E-CO\MR,
- CIFX 70E-DN, CIFX 70E-DN\MR

handle as described in the sections hereafter. The device drawing of your PC card cifX gives information on the manual control elements of your device.



For the installation, uninstalling and replacement of the PC card cifX check any notes in the overview in chapter *Getting Started* on page 35.

6.1 Safety Messages on Personal Injury

Obey to the following safety messages on personal injury, when installing, uninstalling or replacing the PC card cifX.

6.1.1 Electrical Shock Hazard



⚠ WARNING

Lethal Electrical Shock caused by parts with more than 50V!



- HAZARDOUS VOLTAGE inside of the PC or of the connecting device.
- Strictly obey to all safety rules provided by the device's manufacturer in the documentation!
- First disconnect the power plug of the PC or of the connecting device, before you open the cabinet.
- Make sure, that the power supply is off at the PC or at the connecting device.
- Open the PC cabinet and install or remove the PC card cifX only after disconnecting power.

6.2 Property Damage Messages

Obey to the following property damage messages, when installing, uninstalling or replacing the PC card cifX.

6.2.1 Device Destruction by exceeding allowed Supply Voltage

Adhere for all PC cards cifX described in this manual the instruction hereafter:

NOTICE**Device Destruction!**

- Use only the permissible supply voltage to operate the PC card cifX.
 - Operating the PC card cifX with a supply voltage above of the specified range leads to device destruction.
-

6.2.2 Device Destruction by exceeding allowed Signaling Voltage

Adhere for all PC cards cifX described in this manual the instruction hereafter:

NOTICE**Device Destruction!**

- All I/O signal pins at the PC card cifX tolerate only the specified signaling voltage!
 - Operation the PC card cifX with a signaling voltage other than the specified signaling voltage may lead to severe damage to the PC card cifX!
-

For detailed information on the supply and signaling voltage of the PC cards cifX described in this manual, refer to section *Power Supply and Host Interface* on page 33.

6.2.3 Electrostatically sensitive Devices

Adhere to the necessary safety precautions for components that are vulnerable with electrostatic discharge.



NOTICE**Electrostatically sensitive Devices**

- To prevent damage to the PC and the PC card cifX, make sure, that the PC card cifX is grounded via the endplate and the PC and make sure, that you are discharged when you install/uninstall the PC card cifX.
-

6.3 Fix Front Plate Sticker

6.3.1 Fix Front Plate Sticker at CIFX 50-RE, CIFX 50-RE\ET, CIFX 50E-RE and CIFX 50E-RE\ET



Note: Your PC card cifX set contains a set of front plate stickers (9 different stickers). Depending from the loaded firmware the label on each sticker indicates for the respective system the following **LED names**:

- of the **system and communication status LEDs** (*above*)
- of the **RJ45 Ethernet female connector LEDs** (*below*).

Further information to this question you find also in chapter *LED Descriptions* beginning from page 78.

NOTICE

Electrostatically sensitive Devices

- To prevent damage to the PC and the PC card cifX, make sure, that the PC card cifX is grounded via the endplate and the PC and make sure, that you are discharged when you install/uninstall the PC card cifX.
- Use the sticker according to the device and firmware and glue it on the front of the PC card CIFX 50-RE, CIFX 50-RE\ET, CIFX 50E-RE or CIFX 50E-RE\ET.

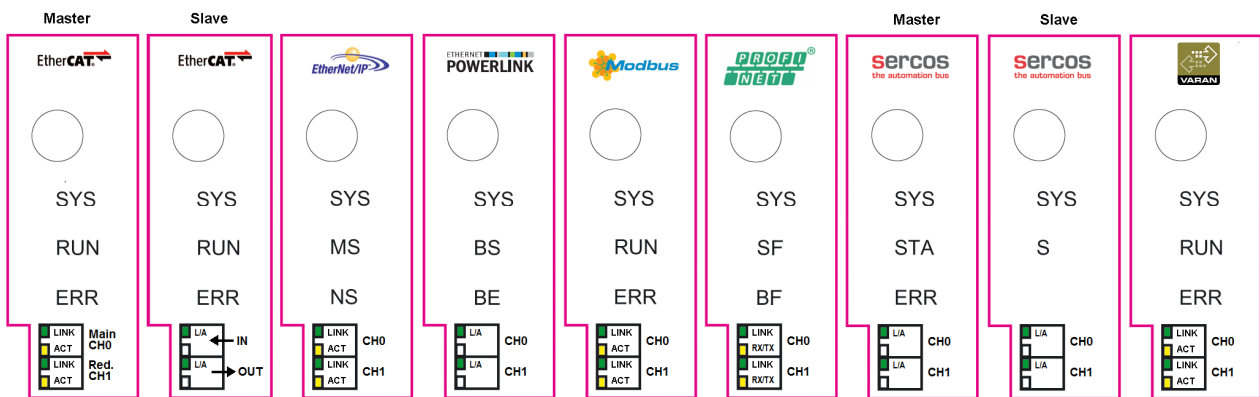

Figure 46: Front Plate Stickers for CIFX 50-RE, CIFX 50-RE\ET, CIFX 50E-RE or CIFX 50E-RE\ET

LED		EtherCAT Master	EtherCAT Slave	EtherNet/IP	Open Modbus/TCP	POWERLINK	PROFINET IO	sercos Master	sercos Slave	VARAN
SYS (yellow/green)		SYS	SYS	SYS	SYS	SYS	SYS	SYS	SYS	SYS
COM 0 (red/ green)		RUN	RUN	MS	RUN	BS	SF	STA	S	RUN
COM 1 (red/ green)		ERR	ERR	NS	ERR	BE	BF	ERR	-	ERR
RJ45 Ch0	green	LINK	L/A IN	LINK	LINK	L/A	LINK	L/A	L/A	LINK
	yellow	ACT	-	ACT	ACT	-	RX/TX	-	-	ACT
RJ45 Ch1	green	LINK	L/A OUT	LINK	LINK	L/A	LINK	L/A	L/A	LINK
	yellow	ACT	-	ACT	ACT	-	RX/TX	-	-	ACT

Table 27: LED Labeling depending of the loaded Firmware

6.3.2 Fix Front Plate Sticker at CIFX 70E-RE, CIFX 70E-RE\MR, CIFX 100EH-RE\CUBE



Note: Your PC card CIFX 70E-RE, CIFX 70E-RE\MR or CIFX 100EH-RE\CUBE set contains a set of front plate stickers (9 different stickers, each 2 parts). Depending from the loaded firmware the label on each sticker indicates for the respective system the following **LED names**:

(1) of the **system and communication status LEDs** (*partial sticker above*)

(2) of the **RJ45 Ethernet female connector LEDs** (*partial sticker below*).

Further information to this question you find also in chapter *LED Descriptions* beginning from page 78.

NOTICE

Electrostatically sensitive Devices

- To prevent damage to the PC and the PC card cifX, make sure, that the PC card cifX is grounded via the endplate and the PC and make sure, that you are discharged when you install/uninstall the PC card cifX.
- Use the two part sticker according to the device and firmware and glue it on the front of the PC card CIFX 70E-RE, CIFX 70E-RE\MR or CIFX 100EH-RE\CUBE.

Front CIFX 100EH-RE\CUBE	Front CIFX 70E-RE, CIFX 70E-RE\MR	How to
<p>The diagram shows the front plate of the CIFX 100EH-RE\CUBE. It features a top section with four LEDs labeled ① and a bottom section with two RJ45 ports labeled ②. Red boxes indicate the placement of the two-part sticker.</p>	<p>The diagram shows the front plate of the CIFX 70E-RE and CIFX 70E-RE\MR. It features a top section with four LEDs labeled ① and a bottom section with two RJ45 ports labeled ②. Red boxes indicate the placement of the two-part sticker.</p>	<p>1. Glue the "partial sticker above" with the system specific names of the system and communication status LEDs above ① of the LEDs COM1, COM0 and SYS on the front plate.</p> <p>2. Glue the "partial sticker below " with the system specific names of the RJ45 Ethernet female connector LEDs below ② of the RJ45 on the front plate.</p>

Table 28: Fix Front Plate Sticker at the CIFX 70E-RE, CIFX 70E-RE\MR or CIFX 100EH-RE\CUBE

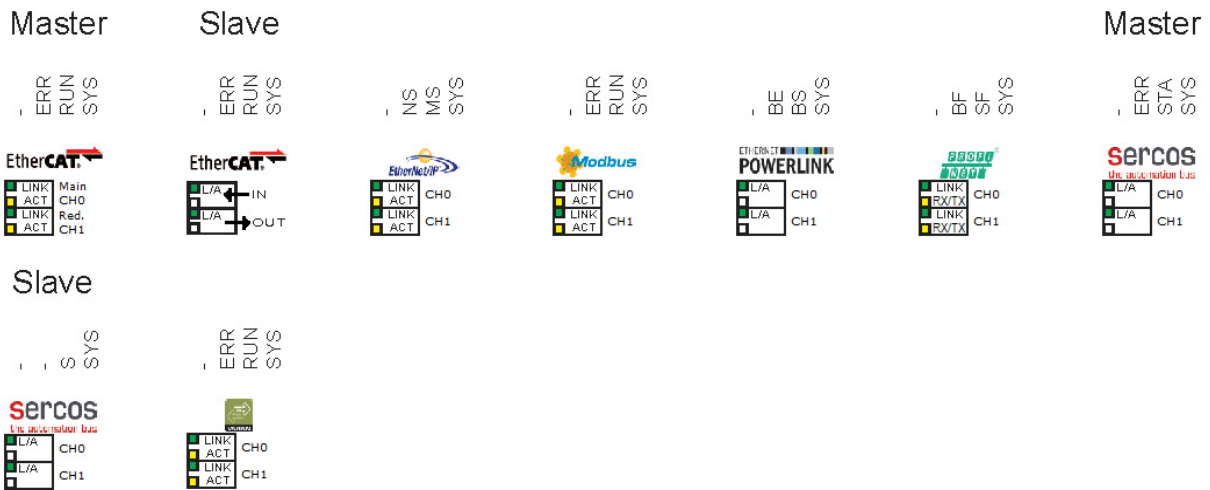

Figure 47: Front Plate Stickers for CIFX 70E-RE, CIFX 70E-REMR

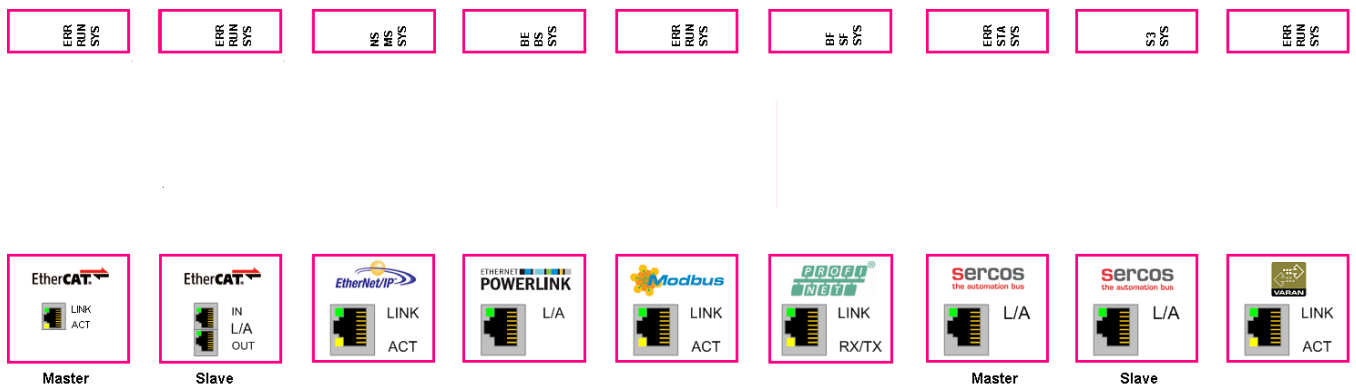

Figure 48: Front Plate Stickers for CIFX 100EH-RE\CUBE

LED		EtherCAT Master	EtherCAT Slave	EtherNet/IP	Open Modbus/TCP	POWERLINK	PROFINET IO	sercos Master	sercos Slave	VARAN
SYS (yellow/green)		SYS	SYS	SYS	SYS	SYS	SYS	SYS	SYS	SYS
COM 0 (red/ green)		RUN	RUN	MS	RUN	BS	SF	STA	S	RUN
COM 1 (red/ green)		ERR	ERR	NS	ERR	BE	BF	ERR	-	ERR
RJ45 Ch0	green	LINK	L/A IN	LINK	LINK	L/A	LINK	L/A	L/A	LINK
	yellow	ACT	-	ACT	ACT	-	RX/TX	-	-	ACT
RJ45 Ch1	green	LINK	L/A OUT	LINK	LINK	L/A	LINK	L/A	L/A	LINK
	yellow	ACT	-	ACT	ACT	-	RX/TX	-	-	ACT

Table 29: LED Labeling depending of the loaded Firmware

6.4 Installing PC Card cifX PCI, PCIe, Low Profile PCIe

1. Adhere to the necessary safety precautions for components that are vulnerable with electrostatic discharge.

NOTICE

Electrostatically sensitive Devices

- To prevent damage to the PC and the PC card cifX, make sure, that the PC card cifX is grounded via the endplate and the PC and make sure, that you are discharged when you install/uninstall the PC card cifX.
2. Fix front plate sticker (only for CIFX 50-RE, CIFX 50-RE\ET, CIFX 50E-RE, CIFX 50E-RE\ET, CIFX 70E-RE, CIFX 70E-RE\MR or CIFX 100EH-RE\CUBE).
 - Use the sticker according to the device and firmware and glue it on the front of the PC card cifX (see section *Fix Front Plate Sticker* on page 72).
 3. Set Slot Number (Card ID).
 - For devices with **Rotary Switch Slot Number (Card ID)** set the **Slot Number (Card ID)**: (Value 0 or a value from 1 to 9), (see section *Rotary Switch for Slot Number (Card ID)* on page 103).
 4. Take safety precautions.

⚠ WARNING

Lethal Electrical Shock caused by parts with more than 50V!

- Disconnect the power plug of the PC or of the connecting device.
- Make sure, that the power supply is off at the PC or at the connecting device.

NOTICE

Device Destruction!

- The PC card CIFX 100EH-RE\CUBE may not be installed in standard PCs. The pin assignment of the PCI Express bus does not meet the standard [bus spec 3]. By consequence malfunction can occur at the PCI express bus.
- Install the PC card CIFX 100EH-RE\CUBE exclusively in KEBA KeControl industry PCs series CP 3XX (Cube).

5. Open cabinet.
 - Open the cabinet of the PC or of the connecting device.
6. Install PC card cifX.
 - Plug the PC card cifX **PCI** into a free PCI slot.
 - Plug the PC card cifX **PCI Express** or **Low Profile PCI Express** into a free PCI express slot.
 - Fix the PC card cifX using the hole intended.

After this:

7. Close cabinet.
 - Close the cabinet of the PC or connecting device.

8. Plug the connecting cable to the Master or Slave.
 - Note for the PC card CIFX 70E-RE, CIFX 70E-RE\MR or CIFX 100EH-RE\CUBE:



Note: The RJ45 socket is only for use in LAN, not for telecommunication circuits. For further information refer to section *Ethernet Interface* on page 98.

- Plug the connecting cable from the PC card cifX to the PC card Master or Slave.
9. Connect the PC or the connecting device to the power supply and switch it on.
 - Connect the PC or the connecting device to the power supply.
 - Switch on the PC or the connecting device.

6.5 Uninstalling the PC Card cifX PCI, PCIe, Low Profile PCIe

1. Take safety precautions.

WARNING

Lethal Electrical Shock caused by parts with more than 50V!

- Disconnect the power plug of the PC or of the connecting device.
- Make sure, that the power supply is off at the PC or at the connecting device.

NOTICE

Electrostatically sensitive Devices

- To prevent damage to the PC and the PC card cifX, make sure, that the PC card cifX is grounded via the endplate and the PC and make sure, that you are discharged when you install/uninstall the PC card cifX.

2. Remove the connecting cable to the Master or Slave.
 - Remove the connecting cable between the PC card cifX to be replaced and the PC card Master or Slave.
3. Open cabinet.
 - Open the cabinet of the PC or of the connecting device.
4. Uninstall PC card cifX.
 - Loosen the PC card cifX.
 - Remove the PC card cifX from the **PCI** slot or from the **PCI express** slot.

After this:

5. Close cabinet.
 - Close the cabinet of the PC or connecting device.

7 Troubleshooting

7.1 Instructions for Problem Solving

In case of any error, follow the instructions for problem solving given here:

General

- Check the PC card cifX operating requirements according to the requirements given in the section *Requirements for Operation* on page 34.

LINK-LEDs

- Check using the LINK LEDs status whether a connection to the Ethernet is established. Therefore use the descriptions on the LINK LEDs in the chapter *LED Descriptions* beginning from page 78.

Cable

- Check that the pin assignment of the cable is correct. This means, the cable by which you connect the PC card cifX to the PC card Master or Slave.

Configuration

- Check the configuration in the Master device and the Slave device. The configuration has to match.

Diagnostic using the Configuration Software SYCON.net

With the menu **Online > Diagnosis**, the diagnostic information of the device is shown. The shown diagnostic information depends on the used protocol.



Note: More information about the device diagnosis and its functions you find in the operating manual of the corresponding Real-Time Ethernet or fieldbus system.

Diagnostic using the netX Configuration Tool

With the menu **netX Configuration Tool > Diagnostics**, the diagnostic information of the device is shown. The shown diagnostic information depends on the used protocol or fieldbus.

8 LED Descriptions

8.1 Overview LEDs Real-Time Ethernet Systems



Note: The meaning of the communication status and the RJ45 LEDs at the PC card cifX is defined by the loaded cifX firmware of the protocol.









LED Naming in the Device Drawing	LED Naming by Protocol									
	EtherCAT Master	EtherCAT Slave	EtherNet/IP	Open-Modbus/TCP	POWERLINK	PROFINET IO	sercos Master	sercos Slave	VARAN	
SYS (System Status)  (yellow/green)	SYS	SYS	SYS	SYS	SYS	SYS	SYS	SYS	SYS	
COM 0 (Communication Status)  (red/green)  (orange = red/green simultaneously)	RUN (Run)	RUN (Run)	MS (Module Status)	RUN (Run)	BS (Bus Status)	SF (System Failure)	STA (Status)	S3 (Status/Error)	RUN (Run)	
COM 1 (Communication Status)  (red/green)	ERR (Error)	ERR (Error)	NS (Network Status)	ERR (Error)	BE (Bus Error)	BF (Bus Failure)	ERR (Error)	-	ERR (Error, Fehler)	
RJ45Ch0	 (green)	LINK (Link)	L/A IN (Link/Activity Input)	LINK (Link)	LINK (Link)	L/A (Link/Activity)	LINK (Link)	L/A (Link/Activity)	L/A (Link/Activity)	LINK (Link)
	 (yellow)	ACT (Activity)	-	ACT (Activity)	ACT (Activity)	-	RX/TX (Receive/Transmit)	-	-	ACT (Activity)
RJ45Ch1	 (green)	-	L/A OUT (Link/Activity Output)	LINK (Link)	LINK (Link)	L/A (Link/Activity)	LINK (Link)	L/A (Link/Activity)	L/A (Link/Activity)	LINK (Link)
	 (yellow)	-	-	ACT (Activity)	ACT (Activity)	-	RX/TX (Receive/Transmit)	-	-	ACT (Activity)

Table 30: Overview LEDs Real-Time Ethernet Systems

8.2 Overview LEDs Fieldbus Systems



LED	Label by Fieldbus System						
	PROFIBUS DP (1 Duo-LED)	PROFIBUS DP (1 Duo LED/channel for 2-Channel Devices)	PROFIBUS MPI (1 Duo LED)	CANopen (1 Duo LED)	DeviceNet (1 Duo LED)	AS-Interface (Master) (1 Duo LED/CH)	CC-Link (Slave) (2 LEDs)
System Status  (yellow/green)	SYS	SYS	SYS	SYS	SYS	SYS	SYS
Communication Status 0  (red/green)	COM Communication Status	COM0 Communication Status 0	COM Communication Status	CAN CANopen Status	MNS Module Network Status	CH0 Channel 0	L RUN/ L Run
Communication Status 1  (red/green)	-	COM1 Communication Status 1	-	-	-	CH1 Channel 1	L ERR L Error

Table 31: Overview LEDs by Fieldbus System



* Descriptions for 2-Communication Status LEDs of PROFIBUS DP Master and Slave devices as well as of CANopen Master and Slave devices of earlier device revisions are included in the user manual for PC cards cifX fieldbus up to manual rev. 23.

8.3 System LED

The subsequent table describes the meaning of the system LED.





LED	Color	State	Meaning
SYS	Duo LED yellow/green		
	 (green)	On	Operating System running
	 (green/yellow)	Blinking green/yellow	Second stage bootloader is waiting for firmware
	 (yellow)	Static	Bootloader netX (= romloader) is waiting for second stage bootloader
	 (off)	Off	Power supply for the device is missing or hardware defect.

Table 32: System Status LED

8.4 EtherCAT Master

The subsequent table describes the meaning of the LEDs for the PC card cifX Real-Time Ethernet Master when the firmware of the EtherCAT Master protocol is loaded to the device.







LED	Color	State	Meaning
RUN Name in the device drawing: COM 0	Duo LED red/green		
	 (off)	Off	INIT: The device is in state INIT
	 (green)	Blinking	PRE-OPERATIONAL: The device is in PRE-OPERATIONAL state
	 (green)	Flickering	BOOT: Device is in Boot mode
	 (green)	Single Flash	SAFE-OPERATIONAL: The device is in SAFE-OPERATIONAL state
ERR Name in the device drawing: COM 1	Duo LED red/green		
	 (red)	On	Master has detected a communication error. The error is indicated in the DPM
LINK/ RJ45 Ch0	LED green		
	 (green)	On	A link is established
ACT/ RJ45 Ch0	LED yellow		
	 (yellow)	Flickering	The device sends/receives Ethernet frames

Table 33: LEDs EtherCAT Master

LED State Definition for EtherCAT Master for the RUN and ERR LEDs

Indicator state	Definition
On	The indicator is constantly on.
Off	The indicator is constantly off.
Blinking	The indicator turns on and off with a frequency of 2,5 Hz: on for 200 ms, followed by off for 200 ms.
Flickering	The indicator turns on and off with a frequency of approximately 10 Hz: on for approximately 50 ms, followed by off for 50 ms.
Single Flash	The indicator shows one short flash (200 ms) followed by a long off phase (1,000 ms).

Table 34: LED State Definition for EtherCAT Master for the RUN and ERR LEDs

8.5 EtherCAT Slave

The subsequent table describes the meaning of the LEDs for the PC card cifX Real-Time Ethernet Slave when the firmware of the EtherCAT Slave protocol is loaded to the device.













LED	Color	State	Meaning
RUN Name in the device drawing: COM 0	Duo LED red/green		
	 (off)	Off	INIT: The device is in state INIT
	 (green)	Blinking	PRE-OPERATIONAL: The device is in state PRE-OPERATIONAL
	 (green)	Single Flash	SAFE-OPERATIONAL: The device is in state SAFE-OPERATIONAL
	 (green)	On	OPERATIONAL: The device is in state OPERATIONAL
ERR Name in the device drawing: COM 1	Duo LED red/green		
	 (off)	Off	No error: The EtherCAT communication of the device is in working condition
	 (red)	Blinking	Invalid Configuration: General Configuration Error Possible reason: State change commanded by master is impossible due to register or object settings.
	 (red)	Single Flash	Local Error: Slave device application has changed the EtherCAT state autonomously. Possible reason 1: A host watchdog timeout has occurred. Possible reason 2: Synchronization Error, device enters Safe-Operational automatically.
	 (red)	Double Flash	Application Watchdog Timeout: An application watchdog timeout has occurred. Possible reason: Sync Manager Watchdog timeout.
L/A IN/ RJ45 Ch0	LED green		
	 (green)	On	A link is established
	 (green)	Flickering	The device sends/receives Ethernet frames
L/A OUT/ RJ45 Ch1	 (off)	Off	No link established
	LED yellow		
RJ45 Ch0	 (yellow)	-	-
RJ45 Ch1			

Table 35: LEDs EtherCAT Slave

LED State Definition for EtherCAT Slave for the RUN and ERR LEDs

Indicator state	Definition
On	The indicator is constantly on.
Off	The indicator is constantly off.
Blinking	The indicator turns on and off with a frequency of 2,5 Hz: on for 200 ms, followed by off for 200 ms.
Flickering	The indicator turns on and off with a frequency of approximately 10 Hz: on for approximately 50 ms, followed by off for 50 ms.
Single Flash	The indicator shows one short flash (200 ms) followed by a long off phase (1,000 ms).
Double Flash	The indicator shows a sequence of two short flashes (each 200 ms), separated by a short off phase (200 ms). The sequence is finished by a long off phase (1,000 ms).

Table 36: LED State Definition for EtherCAT Slave for the RUN and ERR LEDs

8.6 EtherNet/IP Scanner (Master)

The subsequent table describes the meaning of the LEDs for the PC card cifX Real-Time Ethernet (Master) when the firmware of the EtherNet/IP Scanner (Master) protocol is loaded to the device.















LED	Color	State	Meaning
MS Name in the device drawing: COM 0	Duo LED red/green		
	 (green)	On	Device operational: If the device is operating correctly, the module status indicator shall be steady green.
	 (green)	Flashing	Standby: If the device has not been configured, the module status indicator shall be flashing green.
	 (red)	On	Major fault: If the device has detected a non-recoverable major fault, the module status indicator shall be steady red.
	 (red)	Flashing	Minor fault: If the device has detected a recoverable minor fault, the module status indicator shall be flashing red. NOTE: An incorrect or inconsistent configuration would be considered a minor fault.
	 (red/green)	Flashing	Self-test: While the device is performing its power up testing, the module status indicator shall be flashing green/red.
	 (off)	Off	No power: If no power is supplied to the device, the module status indicator shall be steady off.
NS Name in the device drawing: COM 1	Duo LED red/green		
	 (green)	On	Connected: If the device has at least one established connection (even to the Message Router), the network status indicator shall be steady green.
	 (green)	Flashing	No connections: If the device has no established connections, but has obtained an IP address, the network status indicator shall be flashing green.
	 (red)	On	Duplicate IP: If the device has detected that its IP address is already in use, the network status indicator shall be steady red.
	 (red)	Flashing	Connection timeout: If one or more of the connections in which this device is the target has timed out, the network status indicator shall be flashing red. This shall be left only if all timed out connections are reestablished or if the device is reset.
	 (red/green)	Flashing	Self-test: While the device is performing its power up testing, the network status indicator shall be flashing green/red.
	 (off)	Off	Not powered, no IP address: If the device does not have an IP address (or is powered off), the network status indicator shall be steady off.
LINK/RJ45 Ch0 & Ch1	LED green		
	 (green)	On	A connection to the Ethernet exists
	 (off)	Off	The device has no connection to the Ethernet
ACT/RJ45 Ch0 & Ch1	LED yellow		
	 (yellow)	Flashing	The device sends/receives Ethernet frames

Table 37: LEDs EtherNet/IP Scanner (Master)

8.7 EtherNet/IP Adapter (Slave)

The subsequent table describes the meaning of the LEDs for the PC card cifX Real-Time Ethernet (Slave) when the firmware of the EtherNet/IP Adapter (Slave) protocol is loaded to the device.















LED	Color	State	Meaning
MS Name in the device drawing: COM 0	Duo LED red/green		
	 (green)	On	Device operational: If the device is operating correctly, the module status indicator shall be steady green.
	 (green)	Flashing	Standby: If the device has not been configured, the module status indicator shall be flashing green.
	 (red)	On	Major fault: If the device has detected a non-recoverable major fault, the module status indicator shall be steady red.
	 (red)	Flashing	Minor fault: If the device has detected a recoverable minor fault, the module status indicator shall be flashing red. NOTE: An incorrect or inconsistent configuration would be considered a minor fault.
	 (red/green)	Flashing	Self-test: While the device is performing its power up testing, the module status indicator shall be flashing green/red.
	 (off)	Off	No power: If no power is supplied to the device, the module status indicator shall be steady off.
NS Name in the device drawing: COM 1	Duo LED red/green		
	 (green)	On	Connected: If the device has at least one established connection (even to the Message Router), the network status indicator shall be steady green.
	 (green)	Flashing	No connections: If the device has no established connections, but has obtained an IP address, the network status indicator shall be flashing green.
	 (red)	On	Duplicate IP: If the device has detected that its IP address is already in use, the network status indicator shall be steady red.
	 (red)	Flashing	Connection timeout: If one or more of the connections in which this device is the target has timed out, the network status indicator shall be flashing red. This shall be left only if all timed out connections are reestablished or if the device is reset.
	 (red/green)	Flashing	Self-test: While the device is performing its power up testing, the network status indicator shall be flashing green/red.
	 (off)	Off	Not powered, no IP address: If the device does not have an IP address (or is powered off), the network status indicator shall be steady off.
LINK/RJ45 Ch0 & Ch1	LED green		
	 (green)	On	A connection to the Ethernet exists
	 (off)	Off	The device has no connection to the Ethernet
ACT/RJ45 Ch0 & Ch1	LED yellow		
	 (yellow)	Flashing	The device sends/receives Ethernet frames

Table 38: LEDs EtherNet/IP Adapter (Slave)

8.8 Open Modbus/TCP

The subsequent table describes the meaning of the LEDs for the PC card cifX Real-Time Ethernet when the firmware of the Open Modbus/TCP protocol is loaded to the device.











LED	Color	State	Meaning
RUN Name in the device drawing: COM 0	Duo LED red/green		
	 (off)	Off	Not Ready OMB task is not ready
	 (green)	Flashing cyclic with 1Hz	Ready, not configured yet OMB task is ready and not configured yet
	 (green)	Flashing cyclic with 5Hz	Waiting for Communication: OMB task is configured
	 (green)	On	Connected: OMB task has communication – at least one TCP connection is established
ERR Name in the device drawing: COM 1	Duo LED red/green		
	 (off)	Off	No communication error
	 (red)	Flashing cyclic with 2Hz (On/Off Ratio = 25 %)	System error
	 (red)	On	Communication error active
LINK/RJ 45 Ch0 & Ch1	LED green		
	 (green)	On	A connection to the Ethernet exists
	 (off)	Off	The device has no connection to the Ethernet
ACT/RJ 45 Ch0 & Ch1	LED yellow		
	 (yellow)	Flashing	The device sends/receives Ethernet frames

Table 39: LEDs Open Modbus/TCP

8.9 POWERLINK Controlled Node/Slave

The subsequent table describes the meaning of the LEDs for the PC card cifX Real-Time Ethernet (Slave) when the firmware of the POWERLINK Controlled Node Controlled Node/Slave protocol is loaded to the device.







LED	Color	State	Meaning
BS Name in the device drawing: COM 0	Duo LED red/green		
	 (off)	Off	Slave initializing
	 (green)	Flickering	Slave is in 'Basic Ethernet' state
		Single Flash	Slave is in 'Pre-Operational 1' state
		Double Flash	Slave is in 'Pre-Operational 2' state
		Triple Flash	Slave is in 'ReadyToOperate' state
		On	Slave is in 'Operational' state
		Blinking	Slave is in 'Stopped' state
BE Name in the device drawing: COM 1	Duo LED red/green		
	 (off)	Off	Slave has no error
	 (red)	On	Slave has detected an error
L/A/ RJ45 Ch0 & Ch1	LED green		
	 (green)	On	Link: A connection to the Ethernet exists
	 (green)	Flickering	Activity: The device sends/receives Ethernet frames
	 (off)	Off	The device has no connection to the Ethernet
RJ45 Ch0 & Ch1	LED yellow		
	-	-	This LED is not used.

Table 40: LEDs POWERLINK Controlled Node Controlled Node/Slave

LED State Definition for POWERLINK Controlled Node Controlled Node/Slave for the BS/BE LEDs

Indicator state	Definition
On	The indicator is constantly on.
Off	The indicator is constantly off.
Blinking	The indicator turns on and off with a frequency of approximately 2,5 Hz: on for approximately 200 ms, followed by off for 200 ms. Red and green LEDs shall be on alternately.
Flickering	The indicator turns on and off with a frequency of approximately 10 Hz: on for approximately 50 ms, followed by off for 50 ms. Red and green LEDs shall be on alternately.
Single Flash	The indicator shows one short flash (approximately 200 ms) followed by a long off phase (approximately 1,000 ms).
Double Flash	The indicator shows a sequence of two short flashes (each approximately 200 ms), separated by a short off phase (approximately 200 ms). The sequence is finished by a long off phase (approximately 1,000 ms).
Triple Flash	The indicator shows a sequence of three short flashes (each approximately 200 ms), separated by a short off phase (approximately 200 ms). The sequence is finished by a long off phase (approximately 1,000 ms).

Table 41: LED State Definition for POWERLINK Controlled Node Controlled Node/Slave for the BS/BE LEDs

8.10 PROFINET IO-Controller

The subsequent table describes the meaning of the LEDs for the PC card cifX Real-Time Ethernet (Master) when the firmware of the PROFINET IO-Controller protocol is loaded to the device.









LED	Color	State	Meaning
SF Name in the device drawing: COM 0	Duo LED red/green		
	 (off)	Off	No error
	 (red)	On	(together with BF „red ON“) No valid Master license
	 (red)	Flashing cyclic at 2 Hz	System error: Invalid configuration, Watchdog error or internal error
BF Name in the device drawing: COM 1	Duo LED red/green		
	 (off)	Off	No error
	 (red)	On	No Connection: No Link. or (together with SF „red ON“) No valid Master license
	 (red)	Flashing cyclic at 2 Hz	Configuration fault: not all configured IO-Devices are connected.
LINK/RJ45 Ch0 & Ch1	LED green		
	 (green)	On	A connection to the Ethernet exists
	 (off)	Off	The device has no connection to the Ethernet
RX/TX/RJ45 Ch0 & Ch1	LED yellow		
	 (yellow)	Flashing	The device sends/receives Ethernet frames

Table 42: LEDs PROFINET IO-Controller

8.11 PROFINET IO-Device

The subsequent table describes the meaning of the LEDs for the PC card cifX Real-Time Ethernet (Slave) when the firmware of the PROFINET IO-Device protocol is loaded to the device









LED	Color	State	Meaning
SF Name in the device drawing: COM 0	Duo LED red/green		
	 (off)	Off	No error
	 (red)	On	Watchdog timeout; channel, generic or extended diagnosis present; system error
	 (red)	Flashing cyclic at 2 Hz (for 3 sec.)	DCP signal service is initiated via the bus
BF Name in the device drawing: COM 1	Duo LED red/green		
	 (off)	Off	No error
	 (red)	On	No configuration; or low speed physical link; or no physical link
	 (red)	Flashing cyclic at 2 Hz	No data exchange
LINK/RJ45 Ch0 & Ch1	LED green		
	 (green)	On	A connection to the Ethernet exists
	 (off)	Off	The device has no connection to the Ethernet
RX/TX/RJ45 Ch0 & Ch1	LED yellow		
	 (yellow)	Flashing	The device sends/receives Ethernet frames

Table 43: LEDs PROFINET IO-Device

8.12 sercos Master

The subsequent table describes the meaning of the LEDs for the PC card cifX Real-Time Ethernet Master when the firmware of the sercos Master protocol is loaded to the device.



















LED	Color	State	Meaning
STA Name in the device drawing: COM 0	Duo LED red/green		
	 (green)	Blinking	CP0: Communication phase 0
	 (green)	Flickering	Master isn't configured and is in NRT. After a status change this isn't indicated again
	 (green)	Single Flash	CP1: Communication phase 1
	 (green)	Double Flash	CP2: Communication phase 2
	 (green)	Triple Flash	CP3: Communication phase 3
	 (green)	On	CP4: Communication phase 4
	 (off)	Off	NRT: Non Real-time Mode
ERR Name in the device drawing: COM 1	Duo LED red/green		
	 (red)	Blinking	Error in the configuration database.
	 (red)	Flickering	Boot-up was stopped due to an error.
	 (red)	Double Flickering	Slave is missing.
	 (red)	Single Flickering	Channel Init was executed at the Master.
	 (red)	Quadruple Flash	No Master license present in the device
	 (red)	Triple Flash	DPM Watchdog has expired.
	 (red)	Double Flash	Internal Stop of the bus cycle
	 (red)	Single Flash	Bus Sync Error Threshold
 (off)	Off	No error	
L/A/RJ45 Ch0 & Ch1	LED green		
	 (green)	On	Link: A connection to the Ethernet exists
	 (green)	Flickering	Activity: The device sends/receives Ethernet frames
	 (off)	Off	The device has no connection to the Ethernet
RJ45 Ch0 & Ch1	LED yellow		
	-	-	This LED is not used.

Table 44: LEDs sercos Master

LED State Definition for sercos Master for STA and ERR LEDs

Indicator state	Definition
Off	The indicator is constantly off.
Blinking	The indicator turns on and off with a frequency of 2,5 Hz: on for 200 ms, followed by off for 200 ms.
Single Flickering	The indicator turns on and off with a frequency of approximately 10 Hz: on for approximately 50 ms, followed by off for 50 ms.
Double Flickering	The indicator turns on / off / on each for approximately 50 ms, followed by off for 500 ms.
Flickering	The indicator turns on and off once: on for approximately 50 ms, followed by off for 50 ms.
Single Flash	The indicator shows one short flash (200 ms) followed by a long off phase (1,000 ms).
Double Flash	The indicator shows a sequence of two short flashes (each 200 ms), separated by a short off phase (200 ms). The sequence is finished by a long off phase (1,000 ms).
Triple Flash	The indicator shows a sequence of three short flashes (each 200 ms), separated by a short off phase (200 ms). The sequence is finished by a long off phase (1,000 ms).
Quadruple Flash	The indicator shows a sequence of four short flashes (each 200 ms), separated by a short off phase (200 ms). The sequence is finished by a long off phase (1,000 ms).

Table 45: LED State Definition for sercos Master for the STA and ERR LEDs

8.13 sercos Slave

The subsequent table describes the meaning of the LEDs for the PC card cifX Real-Time Ethernet Slave when the firmware of the sercos Slave protocol is loaded to the device.















LED	Color	State	Meaning
S3 Name in the device drawing: COM 0	Duo LED red/green/orange (orange = red/green simultaneously)		
	 (off)	Off	NRT-Mode: No sercos Communication
	 (green)	On	CP4: Communication phase 4, Normal operation, no error
	 (green)	Flashing (4 Hz)	Loopback: The network state has changed from „fast-forward“ to „loopback“.
	 (green/orange)	Flashing (1 x green / 3 s)	CP1: Communication phase 1: Flashing green for 250 ms, then orange on for 2 second and 750 ms
		Flashing (2 x green / 3 s)	CP2: Communication phase 2: Flashing green / orange / green, each for 250 ms, then orange on for 2 seconds and 250 ms
		Flashing (3 x green / 3 s)	CP3: Communication phase 3: Flashing green / orange / green / orange / green, each for 250 ms, then orange on for 1 second and 750 ms
	 (orange/green)	Flashing (4 Hz)	HP0: Hot-plug mode (not yet implemented): Flashing orange permanently
		Flashing (1 x orange / 3 s)	HP2: Hot-plug mode (not yet implemented): Flashing orange for 250 ms, then green on for 2 second an 750 ms
		Flashing (2 x orange / 3 s)	HP3: Hot-plug mode (not yet implemented): Flashing orange / green / orange, each for 250 ms, then green on for 2 seconds and 250 ms
	 (orange)	On	CP0: Communication phase 0
	 (orange)	Flashing (2 Hz)	Identification: Corresponds to C-DEV.Bit 15 in the Slave's Device Control indicating remote address allocation or configuration errors between Master and Slaves (for details refer to sercos Slave V3 Protocol API Manual).
	 (green/ red)	Flashing (2 Hz), <i>The LED flashes at least for 2 seconds from green to red.</i>	MST losses \geq (S-0-1003/2): Depends on IDN S-0-1003 (for details refer to sercos Slave Protocol API manual). Corresponds to S-DEV.Bit 15 in the Device Status indicating a communication warning (Master SYNC telegrams have not been received)
	 (red /orange)	Flashing (2 Hz)	Application error (C1D): See GDP & FSP Status codes class error. See sercos Slave V3 Protocol API Manual.
 (red)	Flashing (2 Hz)	Watchdog error: Application is not running (not yet implemented)	
 (red)	On	Communication Error (C1D): Error detected according to sercos Class 1 Diagnosis, see SCP Status codes class error. See sercos Slave V3 Protocol API Manual.	
Name in the device drawing: COM 1	Duo LED red/green		
	-	-	This LED is not used.
L/A/RJ45 Ch0 & Ch1	LED green		
	 (green)	On	Link: A connection to the Ethernet exists
	 (green)	Flickering	Activity: The device sends/receives Ethernet frames
	 (off)	Off	The device has no connection to the Ethernet
RJ45 Ch0 & Ch1	LED yellow		
	-	-	This LED is not used.

Table 46: LEDs sercos Slave

LED State Definition for sercos Slave for the S3 LED

Indicator state	Definition
On	The indicator is constantly on.
Off	The indicator is constantly off.
Flashing (2 Hz)	The indicator turns on and off with a frequency of 2 Hz: first color for appr. 250 ms, followed by the second color for appr. 250 ms.
Flashing (4 Hz)	The indicator turns on and off with a frequency of 4 Hz: first color for appr. 125 ms, followed by the second color for appr. 125 ms.
Flickering	The indicator turns on and off with a frequency of approximately 10 Hz: on for approximately 50 ms, followed by off for 50 ms.

Table 47: LED State Definition for sercos Slave for the S3 LED

8.14 VARAN Client (Slave)

The subsequent table describes the meaning of the LEDs for the PC card cifX Real-Time Ethernet Slave when the firmware of the VARAN Client (Slave) protocol is loaded to the device.









LED	Color	State	Meaning
RUN Name in the device drawing: COM 0	Duo LED red/green		
	 (green)	Blinking	Configured and communication is inactive.
	 (green)	On	Configured and communication is active.
	 (off)	Off	Not configured.
ERR Name in the device drawing: COM 1	Duo LED red/green		
	 (off)	Off	Configured.
	 (red)	Blinking	Not configured.
	 (red)	On	Communication error occurred.
LINK RJ45 Ch0 & Ch1	LED green		
	 (green)	On	A connection to the Ethernet exists
	 (off)	Off	The device has no connection to the Ethernet
ACT RJ45 Ch0 & Ch1	LED yellow		
	 (yellow)	Flashing	The device sends/receives Ethernet frames

Table 48: LEDs VARAN Client

LED State Definition for VARAN Client for the RUN and ERR LEDs

Indicator state	Definition
On	The indicator is constantly on.
Off	The indicator is constantly off.
Blinking	The indicator turns on and off with a frequency of 5 Hz: on for 100 ms, followed by off for 100 ms.

Table 49: LED State Definition for VARAN Client for the RUN and ERR LEDs

8.15 PROFIBUS DP Master

The subsequent table describes the meaning of the LEDs for the PC card cifX PROFIBUS DP Master when the firmware of the PROFIBUS DP Master protocol is loaded to the device.





LED	Color	State	Meaning
cifX with 1 Communication Status LED (current Hardware Revision)			
COM	Duo LED red/green		
	 (green)	Flashing acyclic	No configuration or stack error
	 (green)	Flashing cyclic	Profibus is configured, but bus communication is not yet released from the application
	 (green)	On	Communication to all Slaves is established
	 (red)	Flashing cyclic	Communication to at least one Slave is disconnected
 (red)	On	Communication to one/all Slaves is disconnected or another serious error has occurred. Redundant Mode: The active Master was not found.	

Table 50: LEDs PROFIBUS DP Master – 1 Communication Status LED (current Hardware Revision)



Note: For 2-Channel Devices per channel works 1 communication LED.



* Descriptions for 2-Communication Status LEDs of earlier device revisions are included in the user manual for PC cards cifX fieldbus up to manual rev. 23.

8.16 PROFIBUS DP Slave

The subsequent table describes the meaning of the LEDs for the PC card cifX PROFIBUS DP Slave when the firmware of the PROFIBUS DP Slave protocol is loaded to the device.





LED	Color	State	Meaning
cifX with 1 Communication Status LED (current Hardware Revision)			
COM	Duo LED red/green		
	 (green)	On	RUN, cyclic communication
	 (red)	On	Wrong configuration at PROFIBUS-DPside.
	 (red)	Flashing cyclic	STOP, no communication, connection error
 (red)	Flashing acyclic	not configured	

Table 51: LEDs PROFIBUS DP Slave – 1 Communication Status LED (current Hardware Revision)



Note: For 2-Channel Devices per channel works 1 communication LED.



* Descriptions for 2-Communication Status LEDs of earlier device revisions are included in the user manual for PC cards cifX fieldbus up to manual rev. 23.

8.17 PROFIBUS MPI Device

The subsequent table describes the meaning of the LEDs for the PC card cifX PROFIBUS MPI device when the firmware of the PROFIBUS MPI protocol is loaded to the device.





LED	Color	State	Meaning
COM	LED green		
	 (green)	On	Status The device currently holds the PROFIBUS token and is able to transfer telegrams of data.
	 (green)	Blinking (regularly) 5 Hz	Status The device is configured to be a part of the PROFIBUS ring, but it must share the PROFIBUS token with other PROFIBUS-Master devices present on the PROFIBUS ring.
	 (green)	Blinking (regularly) 0.5 Hz	Status Automatic baudrate detection is running
	 (off)	Off	Status The device has not been integrated into the PROFIBUS ring, i.e. it has not been configured correctly or has a wrong configuration or has not received the PROFIBUS token.

Table 52: LEDs PROFIBUS MPI

8.18 CANopen Master

The subsequent table describes the meaning of the LEDs for the PC card cifX CANopen Master when the firmware of the CANopen Master protocol is loaded to the device.







LED	Color	State	Meaning
cifX with 1 Communication Status LED (current Hardware Revision)			
CAN	Duo LED red/green		
	 (off)	Off	RESET: The device is executing a reset
	 (green)	Single flash	STOPPED: The device is in STOPPED state
	 (green)	Blinking	PREOPERATIONAL: The device is in the PREOPERATIONAL state
	 (green)	On	OPERATIONAL: The device is in the OPERATIONAL state
	 (red)	Single flash	Warning Limit reached: At least one of the error counters of the CAN controller has reached or exceeded the warning level (too many error frames).
	 (red)	Double flash	Error Control Event: A guard event (NMT Slave or NMT-master) or a heartbeat event (Heartbeat consumer) has occurred.
 (red)	On	Bus Off: The CAN controller is bus off	

Table 53: LEDs CANopen Master – 1 Communication Status LED (current Hardware Revision)

LED State Definition for CANopen Master for the CAN LED

Indicator state	Definition
On	The indicator is constantly on.
Off	The indicator is constantly off.
Flickering	The indicator turns on and off with a frequency of 10 Hz: on for 50 ms, followed by off for 50 ms.
Blinking	The indicator turns on and off with a frequency of 2,5 Hz: on for 200 ms, followed by off for 200 ms.
Single Flash	The indicator shows one short flash (200 ms) followed by a long off phase (1,000 ms).
Double Flash	The indicator shows a sequence of two short flashes (each 200 ms), separated by a short off phase (200 ms). The sequence is finished by a long off phase (1,000 ms).

Table 54: LED State Definition for CANopen Master for the CAN LED



* Descriptions for 2-Communication Status LEDs of earlier device revisions are included in the user manual for PC cards cifX fieldbus up to manual rev. 23.

8.19 CANopen Slave

The subsequent table describes the meaning of the LEDs for the PC card cifX CANopen Slave when the firmware of the CANopen Slave protocol is loaded to the device.









LED	Color	State	Meaning
cifX with 1 Communication Status LED (current Hardware Revision)			
CAN	Duo LED red/green		
	 (off)	Off	RESET: The device is executing a reset
	 (green)	Single flash	STOPPED: The device is in STOPPED state
	 (green)	Blinking	PREOPERATIONAL: The device is in the PREOPERATIONAL state
	 (green)	On	OPERATIONAL: The device is in the OPERATIONAL state
	 (red/green)	Flickering (alternatively red / green)	Auto Baud Rate Detection active: The Device is in the Auto Baud Rate Detection mode
	 (red)	Single flash	Warning Limit reached: At least one of the error counters of the CAN controller has reached or exceeded the warning level (too many error frames).
	 (red)	Double flash	Error Control Event: A guard event (NMT Slave or NMT-master) or a heartbeat event (Heartbeat consumer) has occurred.
 (red)	On	Bus Off: The CAN controller is bus off	

Table 55: LEDs CANopen Slave – 1 Communication Status LED (current Hardware Revision)

LED State Definition for CANopen Slave for the CAN LED

Indicator state	Definition
On	The indicator is constantly on.
Off	The indicator is constantly off.
Flickering	The indicator turns on and off with a frequency of 10 Hz: on for 50 ms, followed by off for 50 ms.
Blinking	The indicator turns on and off with a frequency of 2,5 Hz: on for 200 ms, followed by off for 200 ms.
Single Flash	The indicator shows one short flash (200 ms) followed by a long off phase (1,000 ms).
Double Flash	The indicator shows a sequence of two short flashes (each 200 ms), separated by a short off phase (200 ms). The sequence is finished by a long off phase (1,000 ms).

Table 56: LED State Definition for CANopen Slave for the CAN LED



* Descriptions for 2-Communication Status LEDs of earlier device revisions are included in the user manual for PC cards cifX fieldbus up to manual rev. 23.

8.20 DeviceNet Master

The subsequent table describes the meaning of the LEDs for the PC card cifX DeviceNet Master when the firmware of the DeviceNet Master protocol is loaded to the device.







LED	Color	State	Meaning
MNS	Duo LED red/green		
	 (green)	On	Device Operational AND On-line, Connected Device is online and has established all connections with all Slaves.
	 (green)	Flashing (1 Hz)	Device Operational AND On-line Device is online and has established no connection in the established state. - Configuration missing, incomplete or incorrect.
	 (green/red/off)	Flashing Green/Red/Off	Selftest after power on: Green on for 250 ms, then red on for 250 ms, then off.
	 (red)	Flashing (1 Hz)	Minor Fault and/or Connection Time-Out Device is online and has established one or more connections in the established state. It has data exchange with at least one of the configured Slaves. Minor or recoverable fault: No data exchange with one of the configured Slaves. One or more Slaves are not connected. Connection timeout
	 (red)	On	Critical Fault or Critical Link Failure Critical connection failure; device has detected a network error: duplicate MAC-ID or severe error in CAN network (CAN-bus off).
 (off)	Off	Device is not powered - The device may not be powered. Device is not on-line and/or No Network Power - The device has not completed the Dup_MAC_ID test yet. - The device is powered, but the network power is missing.	

Table 57: LEDs DeviceNet Master

LED State Definition for DeviceNet Master for the MNS LED

Indicator state	Definition
On	The indicator is constantly on.
Off	The indicator is constantly off.
Flashing (1 Hz) green	The indicator turns on and off with a frequency of appr. 1 Hz: on for appr. 500 ms, followed by off for appr. 500 ms.
Flashing (1 Hz) red	The indicator turns on and off with a frequency of appr. 1 Hz: on for appr. 500 ms, followed by off for appr. 500 ms.

Table 58: LED State Definition for DeviceNet Master for the MNS LED

8.21 DeviceNet Slave

The subsequent table describes the meaning of the LEDs for the PC card cifX DeviceNet Slave when the firmware of the DeviceNet Master protocol is loaded to the device.







LED	Color	State	Meaning
MNS	Duo LED red/green		
	 (green)	On	Device Operational AND On-line, Connected Device is online and has established all connections with all Slaves.
	 (green)	Flashing (1 Hz)	Device Operational AND On-line Device is online and has established no connection in the established state. - Configuration missing, incomplete or incorrect.
	 (green/red/off)	Flashing Green/Red/Off	Selftest after power on: Green on for 250 ms, then red on for 250 ms, then off.
	 (red)	Flashing (1 Hz)	Minor Fault and/or Connection Time-Out Device is online and has established one or more connections in the established state. It has data exchange with at least one of the configured Slaves. Minor or recoverable fault: No data exchange with one of the configured Slaves. One or more Slaves are not connected. Connection timeout
	 (red)	On	Critical Fault or Critical Link Failure Critical connection failure; device has detected a network error: duplicate MAC-ID or severe error in CAN network (CAN-bus off).
 (off)	Off	Device is not powered - The device may not be powered. Device is not on-line and/or No Network Power - The device has not completed the Dup_MAC_ID test yet. - The device is powered, but the network power is missing.	

Table 59: LEDs DeviceNet Slave

LED State Definition for DeviceNet Slave for the MNS LED

Indicator state	Definition
On	The indicator is constantly on.
Off	The indicator is constantly off.
Flashing (1 Hz) green	The indicator turns on and off with a frequency of appr. 1 Hz: on for appr. 500 ms, followed by off for appr. 500 ms.
Flashing (1 Hz) red	The indicator turns on and off with a frequency of appr. 1 Hz: on for appr. 500 ms, followed by off for appr. 500 ms.

Table 60: LED State Definition for DeviceNet Slave for the MNS LED

8.22 AS Interface Master

The subsequent table describes the meaning of the LED for the PC card cifX AS Interface Master when the firmware of the AS Interface Master protocol is loaded to the device.













LED	Color	State	Meaning
CH0	Duo LED red/green		
	 (green)	On	No configuration error, data exchange active
	 (green)	Flashing	Configuration error, data exchange active
	 (green)	Flashing fast	The Communication is stopped.
	 (red/green)	Flashing	„Configuration mode“ active
	 (red)	Flashing	AS-Interface power fail
	 (red)	On	Heavy System error or hardware failure
CH1	Duo LED red/green		
	 (green)	On	No configuration error, data exchange active
	 (green)	Flashing	Configuration error, data exchange active
	 (green)	Flashing fast	The Communication is stopped.
	 (red/green)	Flashing	„Configuration mode“ active
	 (red)	Flashing	AS-Interface power fail
	 (red)	On	Heavy System error or hardware failure
 (off)	Off	No configuration found for this channel	

Table 61: LEDs AS Interface Master

8.23 CC-Link Slave

The subsequent table describes the meaning of the LEDs for the PC card cifX CC-Link Slave when the firmware of the CC-Link Slave protocol is loaded to the device.





LED	Color	State	Meaning
L RUN	LED green		
	 (off)	Off	1. Before participating in the network 2. Unable to detect carrier 3. Timeout 4. Resetting hardware
	 (green)	On	Receive both refresh and polling signals or just the refresh signal normally, after participating in the network.
L ERR	LED green		
	 (off)	Off	1. Normal communication 2. Resetting hardware
	 (red)	Blinking	The switch setting has been changed from the setting at the reset cancellation (blinks for 0.4 sec.).
	 (red)	On	1. CRC error 2. Address parameter error (0, 65 or greater is set including the number of occupied stations) 3. Baud rate switch setting error during cancellation of reset (5 or greater)

Table 62: LEDs CC-Link Slave

9 Device Connections and Switches

9.1 Ethernet Interface

For the Ethernet interface use RJ45 plugs and twisted pair cable of category 5 (CAT5) or higher, which consists of 4 twisted cores and has a maximum transmission rate of 100 MBit/s (CAT5).

9.1.1 Ethernet Pin Assignment at the RJ45 Socket



Note: The device supports the **Auto Crossover** function. Due to this fact RX and TX can be switched. The following figure shows the RJ45 standard pin assignment.

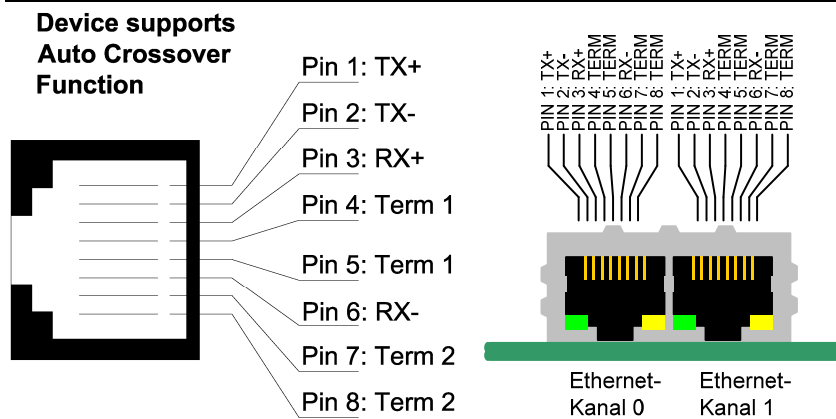

Figure 49: Ethernet Pin Assignment at the RJ45 Socket for cifX or AIFX

Pin	Signal	Meaning
1	TX+	Transmit Data +
2	TX-	Transmit Data -
3	RX+	Receive Data +
4	Term 1	Connected to each other and terminated to PE through RC circuit*
5	Term 1	
6	RX-	Receive Data -
7	Term 2	Connected to each other and terminated to PE through RC circuit*
8	Term 2	
		* Bob Smith Termination

Table 63: Ethernet Pin Assignment at the RJ45 Socket for cifX or AIFX



Further Notes:

- (1) The RJ45 socket is only for use in LAN, not for telecommunication circuits.
- (2) With loaded EtherCAT Master firmware only the RJ45 channel 0 can be used, channel 1 is deactivated. Beginning with the EtherCAT Master firmware version 3 channel 1 can be reactivated if redundancy is activated. For the Open Modbus/TCP firmware with V2.3.4.0 and higher both RJ45channels can be used.

9.1.2 Ethernet Connection Data

Medium	2 x 2 Twisted-Pair cupric cable, CAT5 (100 MBit/s)
Length of cable	Typ. 100 m
Transmission rate	10 MBit/s/100 MBit/s

Table 64: Ethernet Connection Data

9.1.3 Use of Hubs and Switches

For the corresponding communication systems, the use of hubs and/or switches is either forbidden or allowed. The following table shows the acceptable use of hubs and switches by each communication system:

Communication System	Hub	Switch
EtherCAT	forbidden	only allowed between EtherCAT Master and first EtherCAT Slave (100 MBit/s, Full Duplex)
EtherNet/IP	allowed	allowed (10 MBit/s/100 MBit/s, Full or Half Duplex, Auto-Negotiation)
Open Modbus/TCP	allowed	allowed (10 MBit/s/100 MBit/s, Full or Half Duplex, Auto-Negotiation)
POWELINK	allowed	forbidden
PROFINET IO	forbidden	Only allowed if the switch supports 'Priority Tagging' and LLDP (100 MBit/s, Full Duplex)
sercos	forbidden	forbidden
VARAN*	forbidden	forbidden

Table 65: Use of Hubs and Switches

*Instead of hubs and switches VARAN uses splitter. [3]

9.2 PROFIBUS Interface

Isolated RS-485 interface:

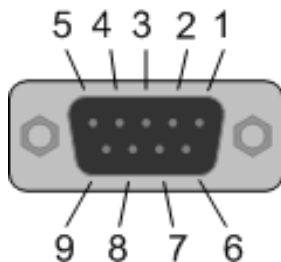

Figure 50: PROFIBUS Interface (DSub female connector, 9 pin), X400

Connection with DSub female connector	Signal	Meaning
3	RxD/TxD-P	Receive/Send Data-P respectively connection B plug
5	DGND	Reference potential
6	VP	Positive supply voltage
8	RxD/TxD-N	Receive/Send Data-N respectively connection A plug

Table 66: PROFIBUS Interface, X400

9.3 CANopen Interface

Isolated ISO 11898 interface:

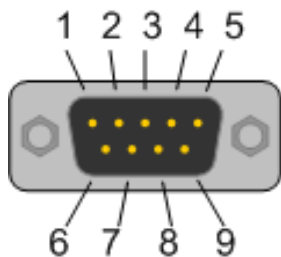

Figure 51: CANopen Interface (DSub male connector, 9 pin), X400

Connection with DSub male connector	Signal	Description
2	CAN_L	CAN_Low Bus Line
3	CAN_GND	CAN Ground
7	CAN_H	CAN High Bus Line
1, 4, 5, 6, 8, 9		Do not connect!

Table 67: CANopen Interface, X400

9.4 DeviceNet Interface

Isolated ISO 11898 interface:

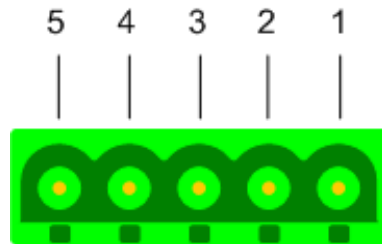

Figure 52: DeviceNet Interface (CombiCon male Connector, 5 pin), X360

Connection with CombiCon male connector	Signal	Color	Description
1	V-	Black	Reference potential DeviceNet supply voltage
2	CAN_L	Blue	CAN Low-Signal
3	Drain		Shield
4	CAN_H	White	CAN High-Signal
5	V+	Red	+24 V DeviceNet supply voltage

Table 68: DeviceNet Interface, X360

9.5 AS-Interface Interface

The AS-Interface Master conforms to Complete Specification 2.11 (Annex B, Version 2.0) the profile M3 (Full Extended Master).

AS-Interface interface according to IEC 364-4-41.

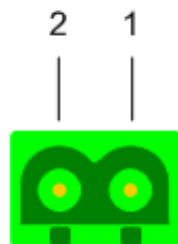

Figure 53: AS-Interface Interface (CombiCon male Connector, 2 pin)

Connection with CombiCon male connector	Signal	Description
1	AS-i +	AS-Interface positive voltage
2	AS-i -	AS-Interface negative voltage

Table 69: AS-Interface Interface

9.6 CC-Link Interface

Isolated RS-485 interface:

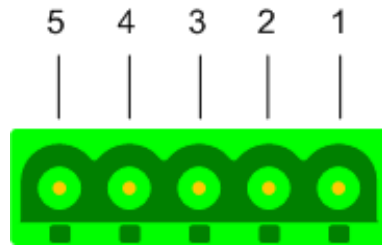

Figure 54: CC-Link Interface (CombiCon male Connector, 5 pin)

Connection with Screw terminal Connector	Signal	Meaning
1	DA	Data A
2	DB	Data B
3	DG	Data Ground
4	SLD	Shield
5	FG	Field Ground

Table 70: CC-Link Interface

9.7 Rotary Switch for Slot Number (Card ID)

Device revisions equipped with a **Rotary Switch Slot Number (Card ID)** are listed separately in section *Hardware: PC Cards cifX* in *Table 2* on page 9.

The **Rotary Switch Slot Number (Card ID)** serves to set the **Slot Number (Card ID)** of the PC cards cifX.

The figure below describes possible switch positions of the **Rotary Switch Slot Number (Card ID)**.



Switch Position	Meaning
0	<p>The value 0 means:</p> <ul style="list-style-type: none"> ▪ no Slot Number (Card ID), i. e. the Slot Number (Card ID) is not used, ▪ for downwards compatibility purposes, ▪ characterizes PC cards cifX not equipped with a Rotary Switch Slot Number (Card ID); i. e. these PC cards cifX are identified via its device number and serial number.
	<p>Example</p> <p>Rotary Switch Slot Number (Card ID) Switch Position 0</p>
1 ... 9	<p>corresponds to the Slot Number (Card ID) 1 ... 9</p>
	<p>Example</p> <p>Rotary Switch Slot Number (Card ID) Switch Position 1</p>

Table 71: Rotary Switch for Slot Number (Card ID), S1

9.7.1 Set Slot Number (Card ID)

If the Slot Number (Card ID) shall not be used:

- set the value 0.

Or

If the Slot Number (Card ID) shall be used:

- Set a value from 1 to 9.



For further information about the **Slot Number (Card ID)** refer to section *The Function „Slot Number (Card ID)“* (page 28) or to the user manual **Software Installation for the PC Cards cifX**, sections *Slot Number (Card ID) in the cifX Device Driver Setup* and *Slot Number (Card ID) in the Configuration Software*.

9.7.2 Note for Device Exchange Service (Replacement Case):



Important: For PC cards cifX with **Rotary Switch Slot Number (Card ID)** in terms of a device exchange service (replacement case) you must set at the replacement card cifX the same **Slot Number (Card ID)** as at the preceding cifX. Then the same firmware and configuration is loaded into the replacement card cifX, as into the preceding cifX.

9.7.3 Rotary Switch Slot Number PC Cards cifX Low Profile

The *Table 72* below shows the **Rotary Switch Slot Number (Card ID)** of the PC cards cifX Low Profile PCI Express in switch position 0 and 1.

	Description
	<p>Rotary Switch Slot Number (Card ID) Switch Position 0</p>
	<p>Rotary Switch Slot Number (Card ID) Switch Position 1</p>

Table 72: Rotary Switch Slot Number (Card ID) PC Cards cifX Low Profile PCI Express

9.8 SYNC Connector (Pin-Assignment, Hardware/Firmware)

9.8.1 Pin Assignment SYNC Connector, X51 (CIFX 50 50E 70E)

Only for:

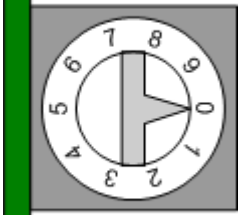
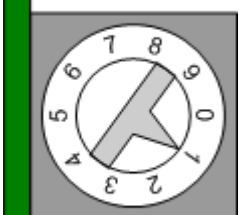
CIFX 50-RE (from hardware Rev. 3 on), CIFX 50-RE\ET, CIFX 50E-RE, CIFX 50E-RE\ET, CIFX 70E-RE

Pin	Signal
1	GND
2	IO_SYNC0
3	IO_SYNC1

Table 73: Pin Assignment for SYNC Connector, X51

9.8.2 Pin Assignment SYNC Connector, J1 (CIFX 100EH)

Only for: CIFX 100EH-RE\CUBE.

Pin	Signal
1	IO_SYNC0
2	<i>Jumper set:</i> SYNC signal is transferred to the PCI Express Bus Pin B24*
	<i>Jumper not set:</i> static high 3,3 V (with pull-up)
3	IO_SYNC1

Table 74: Pin Assignment for SYNC Connector, J1



Note! *

- If the jumper is set on Pin1-Pin2, then the **IO_SYNC0** signal will be transferred to the PCI Express Bus X2 (pin B24).

Or

- If the jumper is set on Pin2-Pin3, then the **IO_SYNC1** signal will be transferred to the PCI Express Bus X2 (pin B24).

Or

- If the no jumper is set, then the signal at the PCI Express Bus X2 pin B24 will be static High **3,3 V** (with pull-up).

Compare section *Pin Assignment for PCI Express Bus CIFX 100EH-RE\CUBE* on page 108.

9.8.3 Items on Hardware

Item	Explanation
SYNC Signal	3,3 V (LVTTTL), maximum load 6 mA
Connector	<p><u>SYNC connector, X51</u> (for the PC cards cifX, as indicated under section <i>Pin Assignment SYNC Connector, X51</i> (CIFX 50 50E 70E) on page 105.) Female connector, 3 pin, pitch spacing 1.25 mm (for example, the type Molex series 51021) and female crimp contacts in design (e. g. type Molex series 50079/50058)</p> <p><u>SYNC connector, J1</u> (for CIFX 100EH-RE\CUBE) Male Connector with jumper, 3 pin, pitch spacing 2,54 mm</p>
Max. Cable Length	<p>Recommendation: Max. 50 mm</p> <p>Note: Take EMC into consideration for the cable laying</p>

Table 75: SYNC Connector: SYNC Signal, Connector, Max. Cable Length

9.8.4 Items on Firmware

The firmware determines the input signal or output signal. The following table shows the meaning of the SYNC signals for each protocol.

Protocol	Signal IO_SYNC0 Input/Output	Signal IO_SYNC1 Input/Output	From Firmware Version	Remarks
EtherCAT Slave	SYNC 0 Output	SYNC 1 Output	-	Configurable
sercos Master	External trigger to start bus cycle Input Rising edge	-	2.0.8.0	-
sercos Slave	CON_CLK Output	DIV_CLK Output	3.0.10.0	Configurable

Table 76: Meaning of the SYNC Signals for each Protocol

9.9 Pin Assignment at the PCI Bus

9.9.1 Overview

For the PC cards cifX PCI, PCI Express and Low Profile PCI Express the table below gives an overview about the pin assignment at the PCI bus.

PC Card cifX	Hardware Revision	PCI Bus Type	PCI Bus [Pins]	Pin Assignment at the PCI Bus		PCI Specification
				acc. to standard	compare section, page	
CIFX 50-RE CIFX 50-RE\ET CIFX 50-DP CIFX 50-2DP CIFX 50-2DP\CO CIFX 50-2DP\DN CIFX 50-CO CIFX 50-2CO CIFX 50-2CO\DN CIFX 50-DN CIFX 50-2DN CIFX 50-2ASM CIFX 50-CC	5 1 5 3 2 1 5 2 1 5 2 2 2	PCI	124	yes	-	[bus spec 1]
CIFX 50E-RE CIFX 50E-RE\ET CIFX 50E-DP CIFX 50E-CO CIFX 50E-DN CIFX 50E-2ASM CIFX 50E-CC	5 1 6 5 5 5 4	PCI Express	36	yes	-	[bus spec 2, Rev. 2.0], [bus spec 3]
CIFX 70E-RE, CIFX 70E-RE\MR, CIFX 70E-DP, CIFX 70E-DP\MR, CIFX 70E-CO, CIFX 70E-COMR, CIFX 70E-DN, CIFX 70E-DNMR	1 1 1 1 1 1 1 1					
CIFX 100EH-RE\ CUBE	4	PCI Express	64	no	<i>Pin Assignment for PCI Express Bus CIFX 100EH-RE\CUBE, 108</i>	[bus spec 2, Rev. 2.0], [bus spec 3]

Table 77: Pin Assignment at the PCI Bus

9.9.2 References PCI Specifications

No.	Specification	Revision	Version	Date	www
[bus spec 1]	PCI Local Bus Specification	2.3	-	February 21, 2003	pcisig.com
[bus spec 2]	PCI Express® Base Specification	2.0	-	January 15, 2007	
[bus spec 3]	PCI Express® Card Electromechanical Specification	2.0	-	April 11, 2007	

Table 78: References PCI Specifications

9.9.3 Pin Assignment for PCI Express Bus CIFX 100EH-RE\CUBE

Only for: CIFX 100EH-RE\CUBE (x1 = One Lane)²

PCI Express Bus X2 (Side B)			PCI Express Bus X1 (Side A)		
Pin	Name	Description	Pin	Name	Description
B1	n. u.	(not used)	A1	PRSNT1#	Hot-Plug presence detect
B2	n. u.	(not used)	A2	n. u.	(not used)
B3	n. u.	(not used)	A3	n. u.	(not used)
B4	GND	Ground	A4	GND	Ground
B5	n. u.	(not used)	A5	JTAG-TCK	JTAG Test Clock
B6	n. u.	(not used)	A6	JTAG-TDI	JTAG Test Data Input
B7	GND	Ground	A7	JTAG-TDO	JTAG Test Data Output
B8	3V3	3,3V Power	A8	JTAG-TMS	JTAG Test Mode Select Input
B9	JTAG-TRST#	JTAG Test Reset	A9	3V3	3,3V Power
B10	n. v.	(not used)	A10	3V3	3,3V Power
B11	n. u.	(not used)	A11	PERST#	PCIe Reset
Key					
B12	n. u.	(not used)	A12	GND	Ground
B13	GND	Ground	A13	PCIe_CLK+	PCIe Clock differential pair
B14	PCIe_TP	Transmitter Lane, differential pair	A14	PCIe_CLK-	
B15	PCIe_TN		A15	GND	Ground
B16	GND	Ground	A16	PCIe_RP	Receiver Lane, differential pair
B17	PRSNT2#	Hot-Plug presence detect	A17	PCIe_RN	
B18	GND	Ground	A18	GND	Ground
B19	n. u.	(not used)	A19	n. u.	(not used)
B20	n. u.	(not used)	A20	n. u.	(not used)
B21	n. u.	(not used)	A21	n. u.	(not used)
B22	n. u.	(not used)	A22	n. u.	(not used)
B23	GND	Ground	A23	n. u.	(not used)
B24	IO_SYNC0 / IO_SYNC1 / 3,3V ³	Real-Time Ethernet SYNC ⁴	A24	n. u.	(not used)
B25	GND	Ground	A25	n. u.	(not used)
B26	SPI_CS#	ID Chip Select	A26	n. u.	(not used)
B27	SPI_MOSI	ID Slave In	A27	n. u.	(not used)
B28	SPI_MISO	ID Slave Out	A28	n. u.	(not used)
B29	SPI_CLK	ID Clock	A29	n. u.	(not used)
B30	GND	Ground	A30	n. u.	(not used)
B31	n. u.	(not used)	A31	n. u.	(not used)
B32	n. u.	(not used)	A32	n. u.	(not used)

Table 79: Pin Assignment for PCI Express-Bus CIFX 100EH-RE\CUBE

²Pinning A19 to A32 / B19 to B32 not standard conform [bus spec 3, page 73-74].

³If at the SYNC connector J1 the jumper is set, the IO_SYNC signal is transferred to the PCI Express Bus X2 pin B24 (jumper on pin1-pin2(J1): **IO_SYNC0**, pin2-pin3(J1): **IO_SYNC1**). If no jumper is set, the signal is **3,3V** static High (with Pull-up). Refer to section *Pin Assignment SYNC Connector, J1 (CIFX 100EH)*, on page 105.

⁴in 3V3 logic.

10 Technical Data

10.1 Technical Data PC Cards cifX



Note: All technical data are temporarily and can be altered without notice.

10.1.1 CIFX 50-RE, CIFX 50-RE\ET

CIFX 50-RE, CIFX 50-RE\ET	Parameter	Value	
Part	Name	CIFX 50-RE	CIFX 50-RE\ET
	Part No.	1250.100	1250.105
	Description	PC Card cifX PCI Real-Time Ethernet Master or Slave	
	Function	Communication interface with PCI and Ethernet interface	
Communication Controller	Type	netX 500 processor	
Integrated Memory	RAM	8 MB SDRAM	
	FLASH	4 MB serial Flash EPROM	
	Size of the Dual-Port Memory	64 KByte	
System Interface	Bus Type	PCI, according to [bus spec 1], refer to section <i>Overview</i> , page 107.	
	Transmission Rate	33 MHz	
	Data Access	DPM or DMA (Direct Memory Access)	
	Width for the data access to the Dual-Port Memory (DPM)	32-Bit	
Ethernet Communication	Supported Real-Time Ethernet communication systems (determined by the loaded firmware)	EtherCAT Master, EtherCAT Slave	
		EtherNet/IP Scanner (Master), EtherNet/IP Adapter (Slave),	
		Open Modbus/TCP	
		POWERLINK Controlled Node/Slave	
		PROFINET IO-Controller (Master), PROFINET IO-Device (Slave)	
		sercos Master, sercos Slave	
	VARAN Client (Slave)		
Ethernet Frame Types	Ethernet II		
Ethernet Interface	Transmission rate	100 MBit/s, 10 MBit/s (depending on loaded firmware)	
	Interface Type	100 BASE-TX, 10 BASE-T (depending on loaded firmware), refer to section <i>Ethernet Interface</i> , page 98.	
	Galvanic Isolation	isolated	
	Isolation Voltage	1000 VDC (tested for 1 minute)	
	Half duplex/Full duplex	depending on loaded firmware, supported (at 100 MBit/s)	
	Auto-Negotiation	depending on loaded firmware	
	Auto-Crossover	depending on loaded firmware	
	Connector	2* RJ45 Socket	
	Channel 0 and 1	With loaded EtherCAT Master firmware only the RJ45 channel 0 can be used, channel 1 is deactivated. Beginning with the EtherCAT Master firmware version 3 channel 1 can be reactivated if redundancy is activated. For Open Modbus/TCP with V2.3.4.0 and higher both	

CIFX 50-RE, CIFX 50-RE\ET	Parameter	Value	
		RJ45 channels can be used.	
Display	LED Display	SYS System Status LED The meaning of the following LEDs depends on the loaded firmware: COM 0 LED Communication Status 0 (duo LED) COM 1 LED Communication Status 1 (duo LED) LED yellow at RJ45Ch0 and RJ45Ch1, LED green for Ethernet Link status, Ethernet Aktivität status and additional status Refer to chapter <i>LED Descriptions</i> , page 78.	
Power supply	Supply Voltage	+3,3 V dc $\pm 5\%$, refer to section <i>Power Supply and Host Interface</i> , page 33.	
	Maximum Current at 3,3 V (typically)	650 mA	
	Connector	Via PCI Bus	
Operation	Rotary Switch Slot Number (Card ID)	To set the Slot Number (Card ID)	
Environmental Conditions		CIFX 50-RE	CIFX 50-RE\ET
	Operating temperature range*	0 °C ... +55 °C	0 °C ... +70 °C
	*Air flow during measurement	0,5m/s	
	Storage temperature range	0 °C ... +70 °C	
	Humidity	10 ... 95% relative humidity, no condensation permitted	
	Environment	For UL compliant usage: The device must be used in a pollution degree 2 environment.	
Device	Dimensions (L x W x H)	120,0 x 86 x 18,5 mm (from hardware revision 3)	
	Mounting/Installation	PCI slot (3,3 V), refer to section <i>Slot for the PC Cards cifX PCI, PCIe and Low Profile PCIe</i> , page 32.	
	RoHS	Yes	
CE Sign	CE Sign	Yes	
	Emission	EN 55011:2009 + A1:2010, CISPR 11:2009, Class A (Radio disturbance characteristics - Limits and methods of measurement)	
	Immunity	EN 61000-4-2:2009 (Electrostatic discharge test) EN 61000-4-3:2006 + A1:2008 + A2:2010 (Radiated, radio-frequency, electromagnetic field test) EN 61000-4-4:2004 + A1:2010 (Burst Electrical fast transients/burst test) EN 61000-4-5:2006 (Surge test) EN 61000-4-6:2009 (to conducted disturbances, induced by radio- frequency fields) EN 61000-4-8:2010 (power frequency magnetic field test) EN 61000-6-2:2005 + B1:2011 (for industrial environments)	
UL Certification	The device CIFX 50-RE is certified according to UL 508.	UL-File-Nr. E221530	
Configuration	Configuration Software Master and Slave	SYCON.net	
	Configuration Software Slave	netX Configuration Tool	

Table 80: Technical Data CIFX 50-RE, CIFX 50-RE\ET

10.1.2 CIFX 50-DP

CIFX 50-DP	Parameter	Value
Part	Name	CIFX 50-DP
	Part No.	1250.410
	Description	PC Card cifX PCI PROFIBUS DP Master or Slave and PROFIBUS MPI Device
	Function	Communication interface with PCI and PROFIBUS interface
Communication Controller	Type	netX 100 processor
Integrated Memory	RAM	8 MB SDRAM
	FLASH	4 MB serial Flash EPROM
	Size of the Dual-Port Memory	64 KByte
System Interface	Bus Type	PCI, according to [bus spec 1], refer to section <i>Overview</i> , page 107.
	Transmission Rate	33 MHz
	Data Access	DPM or DMA (Direct Memory Access)
	Width for the data access to the Dual-Port Memory (DPM)	32-Bit
PROFIBUS Communication	Supported communication standard/ protocol (determined by the loaded firmware)	PROFIBUS DP Master, PROFIBUS DP Slave, PROFIBUS MPI Device
PROFIBUS Interface	Transmission rate	9,6 kBit/s, 19,2 kBit/s, 31,25 kBit/s, 45,45 kBit/s, 93,75 kBit/s, 187,5 kBit/s, 500 kBit/s, 1,5 MBit/s, 3 MBit/s, 6 MBit/s, 12 MBit/s
	Interface Type	RS 485, refer to section <i>PROFIBUS Interface</i> page 100.
	Galvanic Isolation	isolated
	Isolation Voltage	1000 VDC (tested for 1 minute)
	Connector	DSub female Connector, 9 pin
Display	LED Display	<p>SYS System Status LED</p> <p>COM LED Communication Status (duo LED)</p> <p>The meaning of the COM LED depends on the loaded firmware. Refer to chapter <i>LED Descriptions</i>, page 78.</p>
Power supply	Supply Voltage	+3,3 V dc ±5 %, refer to section <i>Power Supply and Host Interface</i> , page 33.
	Maximum Current at 3,3 V (typically)	700 mA
	Connector	Via PCI Bus
Operation	Rotary Switch Slot Number (Card ID)	To set the Slot Number (Card ID)
Environmental Conditions	Operating temperature range*	-20 °C ... +70 °C
	*Air flow during measurement	0,5m/s
	Storage temperature range	-10 °C ... +70 °C
	Humidity	10 ... 95% relative humidity, no condensation permitted
	Environment	For UL compliant usage: The device must be used in a pollution degree 2 environment.
Device	Dimensions (L x W x H)	120,0 x 86 x 18,5 mm (from hardware revision 5)
	Mounting/Installation	PCI slot (3,3 V), refer to section <i>Slot for the PC Cards cifX PCI, PCIe and Low Profile PCIe</i> , page 32.
	RoHS	Yes

CIFX 50-DP	Parameter	Value
CE Sign	CE Sign	Yes
	Emission	EN 55011:2009 + A1:2010, CISPR 11:2009, Class A (Radio disturbance characteristics - Limits and methods of measurement)
	Immunity	EN 61000-4-2:2009 (Electrostatic discharge test) EN 61000-4-3:2006 + A1:2008 + A2:2010 (Radiated, radio-frequency, electromagnetic field test) EN 61000-4-4:2004 + A1:2010 (Burst Electrical fast transients/burst test) EN 61000-4-5:2006 (Surge test) EN 61000-4-6:2009 (to conducted disturbances, induced by radio- frequency fields) EN 61000-4-8:2010 (power frequency magnetic field test) EN 61000-6-2:2005 + B1:2011 (for industrial environments)
UL Certification	The device is certified according to UL 508.	UL-File-Nr. E221530
Configuration	Configuration Software Master and Slave	SYCON.net
	Configuration Software Slave	netX Configuration Tool

Table 81: Technical Data CIFX 50-DP

10.1.3 CIFX 50-2DP

CIFX 50-2DP	Parameter	Value
Part	Name	CIFX 50-2DP
	Part No.	1252.410
	Description	PC Card cifX PCI 2 channel PROFIBUS DP Master or Slave
	Function	Communication interface with PCI and 2 x PROFIBUS interface
Communication Controller	Type	netX 100 processor
Integrated Memory	RAM	8 MB SDRAM
	FLASH	4 MB serial Flash EPROM
	Size of the Dual-Port Memory	64 KByte
System Interface	Bus Type	PCI, according to [bus spec 1], refer to section <i>Overview</i> , page 107.
	Transmission Rate	33 MHz
	Data Access	DPM or DMA (Direct Memory Access)
	Width for the data access to the Dual-Port Memory (DPM)	32-Bit
PROFIBUS Communication	Supported communication standard/ protocol (determined by the loaded firmware)	PROFIBUS DP Master, PROFIBUS DP Slave
PROFIBUS Interface	Transmission rate	9,6 kBit/s, 19,2 kBit/s, 31,25 kBit/s, 45,45 kBit/s, 93,75 kBit/s, 187,5 kBit/s, 500 kBit/s, 1,5 MBit/s, 3 MBit/s, 6 MBit/s, 12 MBit/s
	Interface Type	2 * RS 485, refer to section <i>PROFIBUS Interface</i> p. 100.
	Galvanic Isolation	isolated
	Isolation Voltage	1000 VDC (tested for 1 minute)
	Connector	DSub female Connector, 9 pin

CIFX 50-2DP	Parameter	Value
Display	LED Display	SYS System Status LED COM 0 LED Communication Status 0 (duo LED) COM 1 LED Communication Status 1 (duo LED) The meaning of the LEDs COM0 and COM1 depends on the loaded firmware. Refer to ch. <i>LED Descriptions</i> , p. 78.
Power supply	Supply Voltage	+3,3 V dc $\pm 5\%$, refer to section <i>Power Supply and Host Interface</i> , page 33.
	Maximum Current at 3,3 V (typically)	700 mA
	Connector	Via PCI Bus
Operation	Rotary Switch Slot Number (Card ID)	To set the Slot Number (Card ID)
Environmental Conditions	Operating temperature range*	-20 °C ... +70 °C
	*Air flow during measurement	0,5m/s
	Storage temperature range	-10 °C ... +70 °C
	Humidity	10 ... 95% relative humidity, no condensation permitted
	Environment	For UL compliant usage: The device must be used in a pollution degree 2 environment.
Device	Dimensions (L x W x H)	120 x 94,5 x 18,5 mm
	Mounting/Installation	PCI slot (3,3 V), refer to section <i>Slot for the PC Cards cifX PCI, PCIe and Low Profile PCIe</i> , page 32.
	RoHS	Yes
CE Sign	CE Sign	Yes
	Emission	EN 55011:2009 + A1:2010, CISPR 11:2009, Class A (Radio disturbance characteristics - Limits and methods of measurement)
	Immunity	EN 61000-4-2:2009 (Electrostatic discharge test) EN 61000-4-3:2006 + A1:2008 + A2:2010 (Radiated, radio-frequency, electromagnetic field test) EN 61000-4-4:2004 + A1:2010 (Burst Electrical fast transients/burst test) EN 61000-4-5:2006 (Surge test) EN 61000-4-6:2009 (to conducted disturbances, induced by radio- frequency fields) EN 61000-4-8:2010 (power frequency magnetic field test) EN 61000-6-2:2005 + B1:2011 (for industrial environments)
UL Certification	The device is certified according to UL 508.	UL-File-Nr. E221530
Configuration	Configuration Software Master	SYCON.net

Table 82: Technical Data CIFX 50-2DP

10.1.4 CIFX 50-2DP\CO

CIFX 50-2DP\CO	Parameter	Value
Part	Name	CIFX 50-2DP\CO
	Part No.	1252.470
	Description	PC Card cifX PCI 2 channel - channel X0 PROFIBUS DP Master or Slave, channel X1 CANopen Master or Slave

CIFX 50-2DP\CO	Parameter	Value
	Function	Communication interface with PCI, 1 x PROFIBUS and 1 x CANopen interface
Communication Controller	Type	netX 100 processor
Integrated Memory	RAM	8 MB SDRAM
	FLASH	4 MB serial Flash EPROM
	Size of the Dual-Port Memory	64 KByte
System Interface	Bus Type	PCI, according to [bus spec 1], refer to section <i>Overview</i> , page 107.
	Transmission Rate	33 MHz
	Data Access	DPM or DMA (Direct Memory Access)
	Width for the data access to the Dual-Port Memory (DPM)	32-Bit
PROFIBUS Communication	Supported communication standard/ protocol (determined by the loaded firmware)	PROFIBUS DP Master, PROFIBUS DP Slave
PROFIBUS Interface	Transmission rate	9,6 kBit/s, 19,2 kBit/s, 31,25 kBit/s, 45,45 kBit/s, 93,75 kBit/s, 187,5 kBit/s, 500 kBit/s, 1,5 MBit/s, 3 MBit/s, 6 MBit/s, 12 MBit/s
	Interface Type	2 * RS 485, refer to section <i>PROFIBUS Interface</i> p. 100.
	Galvanic Isolation	isolated
	Isolation Voltage	1000 VDC (tested for 1 minute)
	Connector	DSub female Connector, 9 pin
CANopen Communication	Supported communication standard/ protocol (determined by the loaded firmware)	CANopen Master, CANopen Slave
CANopen Interface	Transmission rate	10 kBit/s, 20 kBit/s, 50 kBit/s, 100 kBit/s, 125 kBit/s, 250 kBit/s, 500 kBit/s, 800 kBit/s, 1 MBit/s
	Interface Type	ISO-11898, refer to section <i>CANopen Interface</i> , page 100.
	Galvanic Isolation	optically isolated
	Isolation Voltage	1000 VDC (tested for 1 minute)
	Connector	DSub female Connector, 9 pin
Display	LED Display	<p>SYS System Status LED</p> <p>COM 0 LED Communication Status 0 (duo LED)</p> <p>CAN 1 CANopen Status 1 (duo LED)</p> <p>The meaning of the LEDs COM0 and CAN1 depends on the loaded firmware. Refer to chapter <i>LED Descriptions</i>, page 78.</p>
Power supply	Supply Voltage	+3,3 V dc $\pm 5\%$, refer to section <i>Power Supply and Host Interface</i> , page 33.
	Maximum Current at 3,3 V (typically)	700 mA
	Connector	Via PCI Bus
Operation	Rotary Switch Slot Number (Card ID)	To set the Slot Number (Card ID)
Environmental Conditions	Operating temperature range*	-20 °C ... +70 °C
	*Air flow during measurement	0,5m/s
	Storage temperature range	-10 °C ... +70 °C
	Humidity	10 ... 95% relative humidity, no condensation permitted
	Environment	For UL compliant usage: The device must be used in a pollution degree 2 environment.

CIFX 50-2DP\CO	Parameter	Value
Device	Dimensions (L x W x H)	120 x 94,5 x 18,5 mm
	Mounting/Installation	PCI slot (3,3 V), refer to section <i>Slot for the PC Cards cifX PCI, PCIe and Low Profile PCIe</i> , page 32.
	RoHS	Yes
CE Sign	CE Sign	Yes
	Emission	EN 55011:2009 + A1:2010, CISPR 11:2009, Class A (Radio disturbance characteristics - Limits and methods of measurement)
	Immunity	EN 61000-4-2:2009 (Electrostatic discharge test) EN 61000-4-3:2006 + A1:2008 + A2:2010 (Radiated, radio-frequency, electromagnetic field test) EN 61000-4-4:2004 + A1:2010 (Burst Electrical fast transients/burst test) EN 61000-4-5:2006 (Surge test) EN 61000-4-6:2009 (to conducted disturbances, induced by radio- frequency fields) EN 61000-4-8:2010 (power frequency magnetic field test) EN 61000-6-2:2005 + B1:2011 (for industrial environments)
UL Certification	The device is certified according to UL 508.	UL-File-Nr. E221530
Configuration	Configuration Software Master	SYCON.net

Table 83: Technical Data CIFX 50-2DP\CO

10.1.5 CIFX 50-2DP\DN

CIFX 50-2DP\DN	Parameter	Value
Part	Name	CIFX 50-2DP\DN
	Part No.	1252.480
	Description	PC Card cifX PCI 2 channel - channel X0 PROFIBUS DP Master or Slave, channel X1 DeviceNet Master or Slave
	Function	Communication interface with PCI, 1 x PROFIBUS and 1 x DeviceNet interface
Communication Controller	Type	netX 100 processor
Integrated Memory	RAM	8 MB SDRAM
	FLASH	4 MB serial Flash EPROM
	Size of the Dual-Port Memory	64 KByte
System Interface	Bus Type	PCI, according to [bus spec 1], refer to section <i>Overview</i> , page 107.
	Transmission Rate	33 MHz
	Data Access	DPM or DMA (Direct Memory Access)
	Width for the data access to the Dual-Port Memory (DPM)	32-Bit
PROFIBUS Communication	Supported communication standard/ protocol (determined by the loaded firmware)	PROFIBUS DP Master, PROFIBUS DP Slave
PROFIBUS Interface	Transmission rate	9,6 kBit/s, 19,2 kBit/s, 31,25 kBit/s, 45,45 kBit/s, 93,75 kBit/s, 187,5 kBit/s, 500 kBit/s, 1,5 MBit/s, 3 MBit/s, 6 MBit/s, 12 MBit/s
	Interface Type	2 * RS 485, refer to section <i>PROFIBUS Interface</i> p. 100.
	Galvanic Isolation	isolated

CIFX 50-2DP\DN	Parameter	Value
	Isolation Voltage	1000 VDC (tested for 1 minute)
	Connector	DSub female Connector, 9 pin
DeviceNet Communication	Supported communication standard/ protocol (determined by the loaded firmware)	DeviceNet Master, DeviceNet Slave
DeviceNet Interface	Transmission rate	125 kBit/s, 250 kBit/s, 500 kBit/s
	Interface Type	ISO-11898 according to DeviceNet specification, refer to section <i>DeviceNet Interface</i> , page 101.
	Galvanic Isolation	optically isolated
	Isolation Voltage	1000 VDC (tested for 1 minute)
	Connector	CombiCon male Connector, 5 pin
Display	LED Display	<p>SYS System Status LED</p> <p>COM 0 LED Communication Status 0 (duo LED)</p> <p>MNS 1 DeviceNet-Status 1 (duo LED)</p> <p>The meaning of the LEDs COM0 and MNS1 depends on the loaded firmware. Refer to chapter <i>LED Descriptions</i>, page 78.</p>
Power supply	Supply Voltage	+3,3 V dc ±5 %, refer to section <i>Power Supply and Host Interface</i> , page 33.
	Maximum Current at 3,3 V (typically)	700 mA
	Connector	Via PCI Bus
Operation	Rotary Switch Slot Number (Card ID)	To set the Slot Number (Card ID)
Environmental Conditions	Operating temperature range*	-20 °C ... +70 °C
	*Air flow during measurment	0,5m/s
	Storage temperature range	-10 °C ... +70 °C
	Humidity	10 ... 95% relative humidity, no condensation permitted
	Environment	For UL compliant usage: The device must be used in a pollution degree 2 environment.
Device	Dimensions (L x W x H)	120 x 94,5 x 18,5 mm
	Mounting/Installation	PCI slot (3,3 V), refer to section <i>Slot for the PC Cards cifX PCI, PCIe and Low Profile PCIe</i> , page 32.
	RoHS	Yes
CE Sign	CE Sign	Yes
	Emission	EN 55011:2009 + A1:2010, CISPR 11:2009, Class A (Radio disturbance characteristics - Limits and methods of measurement)
	Immunity	EN 61000-4-2:2009 (Electrostatic discharge test) EN 61000-4-3:2006 + A1:2008 + A2:2010 (Radiated, radio-frequency, electromagnetic field test) EN 61000-4-4:2004 + A1:2010 (Burst Electrical fast transients/burst test) EN 61000-4-5:2006 (Surge test) EN 61000-4-6:2009 (to conducted disturbances, induced by radio- frequency fields) EN 61000-4-8:2010 (power frequency magnetic field test) EN 61000-6-2:2005 + B1:2011 (for industrial environments)
UL Certification	The device is certified according to UL 508.	UL-File-Nr. E221530

CIFX 50-2DP\DN	Parameter	Value
Configuration	Configuration Software Master	SYCON.net

Table 84: Technical Data CIFX 50-2DP\DN

10.1.6 CIFX 50-CO

CIFX 50-CO	Parameter	Value
Part	Name	CIFX 50-CO
	Part No.	1250.500
	Description	PC Card cifX PCI CANopen Master or Slave
	Function	Communication interface with PCI and CANopen interface
Communication Controller	Type	netX 100 processor
Integrated Memory	RAM	8 MB SDRAM
	FLASH	4 MB serial Flash EPROM
	Size of the Dual-Port Memory	64 KByte
System Interface	Bus Type	PCI, according to [bus spec 1], refer to section <i>Overview</i> , page 107.
	Transmission Rate	33 MHz
	Data Access	DPM or DMA (Direct Memory Access)
	Width for the data access to the Dual-Port Memory (DPM)	32-Bit
CANopen Communication	Supported communication standard/ protocol (determined by the loaded firmware)	CANopen Master, CANopen Slave
CANopen Interface	Transmission rate	10 kBit/s, 20 kBit/s, 50 kBit/s, 100 kBit/s, 125 kBit/s, 250 kBit/s, 500 kBit/s, 800 kBit/s, 1 MBit/s
	Interface Type	ISO-11898, refer to section <i>CANopen Interface</i> , page 100.
	Galvanic Isolation	optically isolated
	Isolation Voltage	1000 VDC (tested for 1 minute)
	Connector	DSub female Connector, 9 pin
Display	LED Display	<p>SYS System Status LED</p> <p>CAN CANopen Status (duo LED)</p> <p>The meaning of the CAN LED depends on the loaded firmware. Refer to chapter <i>LED Descriptions</i>, page 78.</p>
Power supply	Supply Voltage	+3,3 V dc ±5 %, refer to section <i>Power Supply and Host Interface</i> , page 33.
	Maximum Current at 3,3 V (typically)	650 mA
	Connector	Via PCI Bus
Operation	Rotary Switch Slot Number (Card ID)	To set the Slot Number (Card ID)
Environmental Conditions	Operating temperature range*	-20 °C ... +70 °C
	*Air flow during measurement	0,5m/s
	Storage temperature range	-10 °C ... +70 °C
	Humidity	10 ... 95% relative humidity, no condensation permitted
	Environment	For UL compliant usage: The device must be used in a pollution degree 2 environment.
Device	Dimensions (L x W x H)	120,0 x 86 x 18,5 mm (from hardware revision 5)
	Mounting/Installation	PCI slot (3,3 V), refer to section <i>Slot for the PC Cards cifX</i>

CIFX 50-CO	Parameter	Value
		PCI, PCIe and Low Profile PCIe, page 32.
	RoHS	Yes
CE Sign	CE Sign	Yes
	Emission	EN 55011:2009 + A1:2010, CISPR 11:2009, Class A (Radio disturbance characteristics - Limits and methods of measurement)
	Immunity	EN 61000-4-2:2009 (Electrostatic discharge test) EN 61000-4-3:2006 + A1:2008 + A2:2010 (Radiated, radio-frequency, electromagnetic field test) EN 61000-4-4:2004 + A1:2010 (Burst Electrical fast transients/burst test) EN 61000-4-5:2006 (Surge test) EN 61000-4-6:2009 (to conducted disturbances, induced by radio- frequency fields) EN 61000-4-8:2010 (power frequency magnetic field test) EN 61000-6-2:2005 + B1:2011 (for industrial environments)
UL Certification	The device is certified according to UL 508.	UL-File-Nr. E221530
Configuration	Configuration Software Master and Slave	SYCON.net
	Configuration Software Slave	netX Configuration Tool

Table 85: Technical Data CIFX 50-CO

10.1.7 CIFX 50-2CO

CIFX 50-2CO	Parameter	Value
Part	Name	CIFX 50-2CO
	Part No.	1252.500
	Description	PC Card cifX PCI 2 channel CANopen Master or Slave
	Function	Communication interface with PCI and 2 x CANopen interface
Communication Controller	Type	netX 100 processor
Integrated Memory	RAM	8 MB SDRAM
	FLASH	4 MB serial Flash EPROM
	Size of the Dual-Port Memory	64 KByte
System Interface	Bus Type	PCI, according to [bus spec 1], refer to section <i>Overview</i> , page 107.
	Transmission Rate	33 MHz
	Data Access	DPM or DMA (Direct Memory Access)
	Width for the data access to the Dual-Port Memory (DPM)	32-Bit
CANopen Communication	Supported communication standard/ protocol (determined by the loaded firmware)	CANopen Master, CANopen Slave
CANopen Interface	Transmission rate	10 kBit/s, 20 kBit/s, 50 kBit/s, 100 kBit/s, 125 kBit/s, 250 kBit/s, 500 kBit/s, 800 kBit/s, 1 MBit/s
	Interface Type	ISO-11898, refer to section <i>CANopen Interface</i> , page 100.
	Galvanic Isolation	optically isolated
	Isolation Voltage	1000 VDC (tested for 1 minute)
	Connector	DSub female Connector, 9 pin

CIFX 50-2CO	Parameter	Value
Display	LED Display	SYS System Status LED CAN 0 CANopen Status 0 (duo LED) CAN 1 CANopen Status 1 (duo LED) The meaning of the LEDs CAN0 and CAN1 depends on the loaded firmware. Refer to chapter <i>LED Descriptions</i> , page 78.
Power supply	Supply Voltage	+3,3 V dc $\pm 5\%$, refer to section <i>Power Supply and Host Interface</i> , page 33.
	Maximum Current at 3,3 V (typically)	700 mA
	Connector	Via PCI Bus
Operation	Rotary Switch Slot Number (Card ID)	To set the Slot Number (Card ID)
Environmental Conditions	Operating temperature range*	-20 °C ... +70 °C
	*Air flow during measurement	0,5m/s
	Storage temperature range	-10 °C ... +70 °C
	Humidity	10 ... 95% relative humidity, no condensation permitted
	Environment	For UL compliant usage: The device must be used in a pollution degree 2 environment.
Device	Dimensions (L x W x H)	120 x 94,5 x 18,5 mm
	Mounting/Installation	PCI slot (3,3 V), refer to section <i>Slot for the PC Cards cifX PCI, PCIe and Low Profile PCIe</i> , page 32.
	RoHS	Yes
CE Sign	CE Sign	Yes
	Emission	EN 55011:2009 + A1:2010, CISPR 11:2009, Class A (Radio disturbance characteristics - Limits and methods of measurement)
	Immunity	EN 61000-4-2:2009 (Electrostatic discharge test) EN 61000-4-3:2006 + A1:2008 + A2:2010 (Radiated, radio-frequency, electromagnetic field test) EN 61000-4-4:2004 + A1:2010 (Burst Electrical fast transients/burst test) EN 61000-4-5:2006 (Surge test) EN 61000-4-6:2009 (to conducted disturbances, induced by radio- frequency fields) EN 61000-4-8:2010 (power frequency magnetic field test) EN 61000-6-2:2005 + B1:2011 (for industrial environments)
UL Certification	The device is certified according to UL 508.	UL-File-Nr. E221530
Configuration	Configuration Software Master	SYCON.net

Table 86: Technical Data CIFX 50-2CO

10.1.8 CIFX 50-2CO\DN

CIFX 50-2CO\DN	Parameter	Value
Part	Name	CIFX 50-2CO\DN
	Part No.	1252.570
	Description	PC Card cifX PCI 2 channel - channel X0 CANopen Master or Slave, channel X1 DeviceNet Master or Slave

CIFX 50-2CO\DN	Parameter	Value
	Function	Communication interface with PCI, 1 x CANopen and 1 x DeviceNet interface
Communication Controller	Type	netX 100 processor
Integrated Memory	RAM	8 MB SDRAM
	FLASH	4 MB serial Flash EPROM
	Size of the Dual-Port Memory	64 KByte
System Interface	Bus Type	PCI, according to [bus spec 1], refer to section <i>Overview</i> , page 107.
	Transmission Rate	33 MHz
	Data Access	DPM or DMA (Direct Memory Access)
	Width for the data access to the Dual-Port Memory (DPM)	32-Bit
CANopen Communication	Supported communication standard/ protocol (determined by the loaded firmware)	CANopen Master, CANopen Slave
CANopen Interface	Transmission rate	10 kBit/s, 20 kBit/s, 50 kBit/s, 100 kBit/s, 125 kBit/s, 250 kBit/s, 500 kBit/s, 800 kBit/s, 1 MBit/s
	Interface Type	ISO-11898, refer to section <i>CANopen Interface</i> , page 100.
	Galvanic Isolation	optically isolated
	Isolation Voltage	1000 VDC (tested for 1 minute)
	Connector	DSub female Connector, 9 pin
DeviceNet Communication	Supported communication standard/ protocol (determined by the loaded firmware)	DeviceNet Master, DeviceNet Slave
DeviceNet Interface	Transmission rate	125 kBit/s, 250 kBit/s, 500 kBit/s
	Interface Type	ISO-11898 according to DeviceNet specification, refer to section <i>DeviceNet Interface</i> , page 101.
	Galvanic Isolation	optically isolated
	Isolation Voltage	1000 VDC (tested for 1 minute)
	Connector	CombiCon male Connector, 5 pin
Display	LED Display	<p>SYS System Status LED</p> <p>CAN 0 CANopen Status 0 (duo LED)</p> <p>MNS 1 CANopen Status 1 (duo LED)</p> <p>The meaning of the LEDs CAN0 and MNS1 depends on the loaded firmware. Refer to chapter <i>LED Descriptions</i>, page 78.</p>
Power supply	Supply Voltage	+3,3 V dc ±5 %, refer to section <i>Power Supply and Host Interface</i> , page 33.
	Maximum Current at 3,3 V (typically)	700 mA
	Connector	Via PCI Bus
Operation	Rotary Switch Slot Number (Card ID)	To set the Slot Number (Card ID)
Environmental Conditions	Operating temperature range*	-20 °C ... +70 °C
	*Air flow during measurement	0,5m/s
	Storage temperature range	-10 °C ... +70 °C
	Humidity	10 ... 95% relative humidity, no condensation permitted
	Environment	For UL compliant usage: The device must be used in a pollution degree 2 environment.

CIFX 50-2CO\DN	Parameter	Value
Device	Dimensions (L x W x H)	120 x 94,5 x 18,5 mm
	Mounting/Installation	PCI slot (3,3 V), refer to section <i>Slot for the PC Cards cifX PCI, PCIe and Low Profile PCIe</i> , page 32.
	RoHS	Yes
CE Sign	CE Sign	Yes
	Emission	EN 55011:2009 + A1:2010, CISPR 11:2009, Class A (Radio disturbance characteristics - Limits and methods of measurement)
	Immunity	EN 61000-4-2:2009 (Electrostatic discharge test) EN 61000-4-3:2006 + A1:2008 + A2:2010 (Radiated, radio-frequency, electromagnetic field test) EN 61000-4-4:2004 + A1:2010 (Burst Electrical fast transients/burst test) EN 61000-4-5:2006 (Surge test) EN 61000-4-6:2009 (to conducted disturbances, induced by radio- frequency fields) EN 61000-4-8:2010 (power frequency magnetic field test) EN 61000-6-2:2005 + B1:2011 (for industrial environments)
UL Certification	The device is certified according to UL 508.	UL-File-Nr. E221530
Configuration	Configuration Software Master	SYCON.net

Table 87: Technical Data CIFX 50-2CO\DN

10.1.9 CIFX 50-DN

CIFX 50-DN	Parameter	Value
Part	Name	CIFX 50-DN
	Part No.	1250.510
	Description	PC Card cifX PCI DeviceNet Master or Slave
	Function	Communication interface with PCI and DeviceNet interface
Communication Controller	Type	netX 100 processor
Integrated Memory	RAM	8 MB SDRAM
	FLASH	4 MB serial Flash EPROM
	Size of the Dual-Port Memory	64 KByte
System Interface	Bus Type	PCI, according to [bus spec 1], refer to section <i>Overview</i> , page 107.
	Transmission Rate	33 MHz
	Data Access	DPM or DMA (Direct Memory Access)
	Width for the data access to the Dual-Port Memory (DPM)	32-Bit
DeviceNet Communication	Supported communication standard/ protocol (determined by the loaded firmware)	DeviceNet Master, DeviceNet Slave
DeviceNet Interface	Transmission rate	125 kBit/s, 250 kBit/s, 500 kBit/s
	Interface Type	ISO-11898 according to DeviceNet specification, refer to section <i>DeviceNet Interface</i> , page 101.
	Galvanic Isolation	optically isolated
	Isolation Voltage	1000 VDC (tested for 1 minute)
	Connector	CombiCon male Connector, 5 pin

CIFX 50-DN	Parameter	Value
Display	LED Display	SYS System Status LED MNS Module Network Status (duo LED) The meaning of the MNS LED depends on the loaded firmware. Refer to chapter <i>LED Descriptions</i> , page 78.
Power supply	Supply Voltage	+3,3 V dc $\pm 5\%$, refer to section <i>Power Supply and Host Interface</i> , page 33.
	Maximum Current at 3,3 V (typically)	650 mA
	Connector	Via PCI Bus
Operation	Rotary Switch Slot Number (Card ID)	To set the Slot Number (Card ID)
Environmental Conditions	Operating temperature range*	-20 °C ... +70 °C
	*Air flow during measurement	0,5m/s
	Storage temperature range	-10 °C ... +70 °C
	Humidity	10 ... 95% relative humidity, no condensation permitted
	Environment	For UL compliant usage: The device must be used in a pollution degree 2 environment.
Device	Dimensions (L x W x H)	120,0 x 86 x 18,5 mm (from hardware revision 5)
	Mounting/Installation	PCI slot (3,3 V), refer to section <i>Slot for the PC Cards cifX PCI, PCIe and Low Profile PCIe</i> , page 32.
	RoHS	Yes
CE Sign	CE Sign	Yes
	Emission	EN 55011:2009 + A1:2010, CISPR 11:2009, Class A (Radio disturbance characteristics - Limits and methods of measurement)
	Immunity	EN 61000-4-2:2009 (Electrostatic discharge test) EN 61000-4-3:2006 + A1:2008 + A2:2010 (Radiated, radio-frequency, electromagnetic field test) EN 61000-4-4:2004 + A1:2010 (Burst Electrical fast transients/burst test) EN 61000-4-5:2006 (Surge test) EN 61000-4-6:2009 (to conducted disturbances, induced by radio- frequency fields) EN 61000-4-8:2010 (power frequency magnetic field test) EN 61000-6-2:2005 + B1:2011 (for industrial environments)
UL Certification	The device is certified according to UL 508.	UL-File-Nr. E221530
Configuration	Configuration Software Master and Slave	SYCON.net
	Configuration Software Slave	netX Configuration Tool

Table 88: Technical Data CIFX 50-DN

10.1.10 CIFX 50-2DN

CIFX 50-2DN	Parameter	Value
Part	Name	CIFX 50-2DN
	Part No.	1252.510
	Description	PC Card cifX PCI 2 channel DeviceNet Master or Slave
	Function	Communication interface with PCI and 2 x DeviceNet interface

CIFX 50-2DN	Parameter	Value
Communication Controller	Type	netX 100 processor
Integrated Memory	RAM	8 MB SDRAM
	FLASH	4 MB serial Flash EPROM
	Size of the Dual-Port Memory	64 KByte
System Interface	Bus Type	PCI, according to [bus spec 1], refer to section <i>Overview</i> , page 107.
	Transmission Rate	33 MHz
	Data Access	DPM or DMA (Direct Memory Access)
	Width for the data access to the Dual-Port Memory (DPM)	32-Bit
DeviceNet Communication	Supported communication standard/ protocol (determined by the loaded firmware)	DeviceNet Master, DeviceNet Slave
DeviceNet Interface	Transmission rate	125 kBit/s, 250 kBit/s, 500 kBit/s
	Interface Type	ISO-11898 according to DeviceNet specification, refer to section <i>DeviceNet Interface</i> , page 101.
	Galvanic Isolation	optically isolated
	Isolation Voltage	1000 VDC (tested for 1 minute)
	Connector	CombiCon male Connector, 5 pin
Display	LED Display	<p>SYS System Status LED</p> <p>MNS 0 Module Network Status 0 (duo LED)</p> <p>MNS 1 Module Network Status 1 (duo LED)</p> <p>The meaning of the LEDs MNS 0 and MNS 1 depends on the loaded firmware. Refer to chapter <i>LED Descriptions</i>, page 78.</p>
Power supply	Supply Voltage	+3,3 V dc $\pm 5\%$, refer to section <i>Power Supply and Host Interface</i> , page 33.
	Maximum Current at 3,3 V (typically)	700 mA
	Connector	Via PCI Bus
Operation	Rotary Switch Slot Number (Card ID)	To set the Slot Number (Card ID)
Environmental Conditions	Operating temperature range*	-20 °C ... +70 °C
	*Air flow during measurement	0,5m/s
	Storage temperature range	-10 °C ... +70 °C
	Humidity	10 ... 95% relative humidity, no condensation permitted
	Environment	For UL compliant usage: The device must be used in a pollution degree 2 environment.
Device	Dimensions (L x W x H)	120 x 94,5 x 18,5 mm
	Mounting/Installation	PCI slot (3,3 V), refer to section <i>Slot for the PC Cards cifX PCI, PCIe and Low Profile PCIe</i> , page 32.
	RoHS	Yes
CE Sign	CE Sign	Yes
	Emission	EN 55011:2009 + A1:2010, CISPR 11:2009, Class A (Radio disturbance characteristics - Limits and methods of measurement)
	Immunity	EN 61000-4-2:2009 (Electrostatic discharge test) EN 61000-4-3:2006 + A1:2008 + A2:2010 (Radiated, radio-frequency, electromagnetic field test)

CIFX 50-2DN	Parameter	Value
		EN 61000-4-4:2004 + A1:2010 (Burst Electrical fast transients/burst test) EN 61000-4-5:2006 (Surge test) EN 61000-4-6:2009 (to conducted disturbances, induced by radio- frequency fields) EN 61000-4-8:2010 (power frequency magnetic field test) EN 61000-6-2:2005 + B1:2011 (for industrial environments)
UL Certification	The device is certified according to UL 508.	UL-File-Nr. E221530
Configuration	Configuration Software Master	SYCON.net

Table 89: Technical Data CIFX 50-2DN

10.1.11 CIFX 50-2ASM

CIFX 50-2ASM	Parameter	Value
Part	Name	CIFX 50-2ASM
	Part No.	1252.630
	Description	PC Card cifX PCI 2 channel AS-Interface Master
	Function	Communication interface with PCI and 2 x AS-Interface interface
Communication Controller	Type	netX 100 processor
Integrated Memory	RAM	8 MB SDRAM
	FLASH	4 MB serial Flash EPROM
	Size of the Dual-Port Memory	64 KByte
System Interface	Bus Type	PCI, according to [bus spec 1], refer to section <i>Overview</i> , page 107.
	Transmission Rate	33 MHz
	Data Access	DPM or DMA (Direct Memory Access)
	Width for the data access to the Dual-Port Memory (DPM)	32-Bit
AS-Interface Communication	Supported communication standard/ protocol (determined by the loaded firmware)	AS-Interface Master
AS-Interface Interface	Transmission rate	166,67 kBit/s
	Interface Type	2 *, acc. to IEC 364-4-41, refer to section <i>AS-Interface Interface</i> , page 101.
	Galvanic Isolation	optically isolated
	Isolation Voltage	1000 VDC (tested for 1 minute)
	Connector	CombiCon male Connector, 2 pin
Display	LED Display	SYS System Status LED CH1 LED channel 1 (duo LED) CH2 LED channel 2 (duo LED) Refer to chapter <i>LED Descriptions</i> , page 78.
Power supply	Supply Voltage	+3,3 V dc ±5 %, refer to section <i>Power Supply and Host Interface</i> , page 33.
	Maximum Current at 3,3 V (typically)	700 mA
	Connector	Via PCI Bus
Operation	Rotary Switch Slot Number	To set the Slot Number (Card ID)

CIFX 50-2ASM	Parameter	Value
	(Card ID)	
Environmental Conditions	Operating temperature range*	-20 °C ... +55 °C
	*Air flow during measurment	0,5m/s
	Storage temperature range	-10 °C ... +70 °C
	Humidity	10 ... 95% relative humidity, no condensation permitted
	Environment	For UL compliant usage: The device must be used in a pollution degree 2 environment.
Device	Dimensions (L x W x H)	120 x 94,5 x 18,5 mm
	Mounting/Installation	PCI slot (3,3 V), refer to section <i>Slot for the PC Cards cifX PCI, PCIe and Low Profile PCIe</i> , page 32.
	RoHS	Yes
CE Sign	CE Sign	Yes
	Emission	EN 55011:2009 + A1:2010, CISPR 11:2009, Class A (Radio disturbance characteristics - Limits and methods of measurement)
	Immunity	EN 61000-4-2:2009 (Electrostatic discharge test) EN 61000-4-3:2006 + A1:2008 + A2:2010 (Radiated, radio-frequency, electromagnetic field test) EN 61000-4-4:2004 + A1:2010 (Burst Electrical fast transients/burst test) EN 61000-4-5:2006 (Surge test) EN 61000-4-6:2009 (to conducted disturbances, induced by radio- frequency fields) EN 61000-4-8:2010 (power frequency magnetic field test) EN 61000-6-2:2005 + B1:2011 (for industrial environments)
UL Certification	The device is certified according to UL 508.	UL-File-Nr. E221530
Configuration	Configuration Software	SYCON.net

Table 90: Technical Data CIFX 50-2ASM

10.1.12 CIFX 50-CC

CIFX 50-CC	Parameter	Value
Part	Name	CIFX 50-CC
	Part No.	1250.740
	Description	PC Card cifX PCI CC-Link Slave
	Function	Communication interface with PCI and CC-Link interface
Communication Controller	Type	netX 100 processor
Integrated Memory	RAM	8 MB SDRAM
	FLASH	4 MB serial Flash EPROM
	Size of the Dual-Port Memory	64 KByte
System Interface	Bus Type	PCI, according to [bus spec 1], refer to section <i>Overview</i> , page 107.
	Transmission Rate	33 MHz
	Data Access	DPM or DMA (Direct Memory Access)
	Width for the data access to the Dual-Port Memory (DPM)	32-Bit
CC-Link Communication	Supported communication standard/ protocol (determined by the loaded firmware)	CC-Link Slave
CC-Link Interface	Transmission rate	156 kBit/s, 625 kBit/s, 2500 kBit/s, 5 MBit/s, 10 MBit/s
	Interface Type	RS-485, refer to section <i>CC-Link Interface</i> , page 102.
	Galvanic Isolation	optically isolated
	Isolation Voltage	1000 VDC (tested for 1 minute)
	Connector	CombiCon male Connector, 5 pin
Display	LED Display	SYS System Status LED L RUN LED L Run (Duo LED) L ERR LED L Error (Duo LED) Refer to chapter <i>LED Descriptions</i> , page 78.
Power supply	Supply Voltage	+3,3 V dc ±5 %, refer to section <i>Power Supply and Host Interface</i> , page 33.
	Maximum Current at 3,3 V (typically)	650 mA
	Connector	Via PCI Bus
Operation	Rotary Switch Slot Number (Card ID)	To set the Slot Number (Card ID)
Environmental Conditions	Operating temperature range*	-20 °C ... +55 °C
	*Air flow during measurment	0,5m/s
	Storage temperature range	-10 °C ... +70 °C
	Humidity	10 ... 95% relative humidity, no condensation permitted
	Environment	For UL compliant usage: The device must be used in a pollution degree 2 environment.
Device	Dimensions (L x W x H)	120 x 85,4 x 18,5 mm (from hardware revision 2)
	Mounting/Installation	PCI slot (3,3 V), refer to section <i>Slot for the PC Cards cifX PCI, PCIe and Low Profile PCIe</i> , page 32.
	RoHS	Yes
CE Sign	CE Sign	Yes

CIFX 50-CC	Parameter	Value
	Emission	EN 55011:2009 + A1:2010, CISPR 11:2009, Class A (Radio disturbance characteristics - Limits and methods of measurement)
	Immunity	EN 61000-4-2:2009 (Electrostatic discharge test) EN 61000-4-3:2006 + A1:2008 + A2:2010 (Radiated, radio-frequency, electromagnetic field test) EN 61000-4-4:2004 + A1:2010 (Burst Electrical fast transients/burst test) EN 61000-4-5:2006 (Surge test) EN 61000-4-6:2009 (to conducted disturbances, induced by radio- frequency fields) EN 61000-4-8:2010 (power frequency magnetic field test) EN 61000-6-2:2005 + B1:2011 (for industrial environments)
UL Certification	The device is certified according to UL 508.	UL-File-Nr. E221530
Configuration	Configuration Software	SYCON.net or netX Configuration Tool

Table 91: Technical Data CIFX 50-CC

10.1.13 CIFX 50E-RE, CIFX 50E-RE\ET

CIFX 50E-RE, CIFX 50E-RE\ET	Parameter	Value	
Part	Name	CIFX 50E-RE	CIFX 50E-RE\ET
	Part No.	1251.100	1251.105
	Description	PC Card cifX PCI Express Real-Time Ethernet Master or Slave	
	Function	Communication interface with PCI Express and Ethernet interface	
Communication Controller	Type	netX 500 processor	
Integrated Memory	RAM	8 MB SDRAM	
	FLASH	4 MB serial Flash EPROM	
	Size of the Dual-Port Memory	64 KByte	
System Interface	Bus Type	PCI Express, One Lane Port, according to [bus spec 2, Rev. 2.0] and [bus spec 3], refer to section <i>Overview</i> , page 107.	
	Transmission Rate	2 GBit/s	
	Data Access	DPM or DMA* (Direct Memory Access); *beginning from Hardware Revision 4	
	Width for the data access to the Dual-Port Memory (DPM)	32-Bit	
Ethernet Communication	Supported Real-Time Ethernet communication systems (determined by the loaded firmware)	EtherCAT Master, EtherCAT Slave	
		EtherNet/IP Scanner (Master), EtherNet/IP Adapter (Slave),	
		Open Modbus/TCP	
		POWERLINK Controlled Node/Slave	
		PROFINET IO-Controller (Master), PROFINET IO-Device (Slave)	
		sercos Master, sercos Slave	
		VARAN Client (Slave)	

CIFX 50E-RE, CIFX 50E-RE\ET	Parameter	Value	
	Ethernet Frame Types	Ethernet II	
Ethernet Interface	Transmission rate	100 MBit/s, 10 MBit/s (depending on loaded firmware)	
	Interface Type	100 BASE-TX, 10 BASE-T (depending on loaded firmware), refer to section <i>Ethernet Interface</i> , page 98.	
	Galvanic Isolation	isolated	
	Isolation Voltage	1000 VDC (tested for 1 minute)	
	Half duplex/Full duplex	depending on loaded firmware, supported (at 100 MBit/s)	
	Auto-Negotiation	depending on loaded firmware	
	Auto-Crossover	depending on loaded firmware	
	Connector	2* RJ45 Socket	
Channel 0 and 1	With loaded EtherCAT Master firmware only the RJ45 channel 0 can be used, channel 1 is deactivated. Beginning with the EtherCAT Master firmware version 3 channel 1 can be reactivated if redundancy is activated. For Open Modbus/TCP with V2.3.4.0 and higher both RJ45 channels can be used.		
Display	LED Display	<p>SYS System Status LED</p> <p>The meaning of the following LEDs depends on the loaded firmware:</p> <p>COM 0 LED Communication Status 0 (duo LED)</p> <p>COM 1 LED Communication Status 1 (duo LED)</p> <p>LED yellow at RJ45Ch0 and RJ45Ch1, for Ethernet Link status, Ethernet Aktivität status and additional status</p> <p>LED green</p> <p>Refer to chapter <i>LED Descriptions</i>, page 78.</p>	
Power supply	Supply Voltage	+3,3 V dc ±5 %, refer to section <i>Power Supply and Host Interface</i> , page 33.	
	Maximum Current at 3,3 V (typically)	800 mA	
	Connector	Via PCI Express Bus	
Operation	Rotary Switch Slot Number (Card ID)	To set the Slot Number (Card ID)	
Environmental Conditions		CIFX 50E-RE	CIFX 50E-RE\ET
	Operating temperature range*	0 °C ... +55 °C	0 °C ... +70 °C
	*Air flow during measurement	0,5m/s	
	Storage temperature range	0 °C ... +70 °C	
	Humidity	10 ... 95% relative humidity, no condensation permitted	
Environment	For UL compliant usage: The device must be used in a pollution degree 2 environment.		
Device	Dimensions (L x W x H)	120,0 x 86 x 18,5 mm (from hardware revision 4)	
	Mounting/Installation	PCI Express x1 slot (3.3 V), refer to section <i>Slot for the PC Cards cifX PCI, PCIe and Low Profile PCIe</i> , page 32.	
	RoHS	Yes	
CE Sign	CE Sign	Yes	

CIFX 50E-RE, CIFX 50E-RE\ET	Parameter	Value
	Emission	EN 55011:2009 + A1:2010, CISPR 11:2009, Class A (Radio disturbance characteristics - Limits and methods of measurement)
	Immunity	EN 61000-4-2:2009 (Electrostatic discharge test) EN 61000-4-3:2006 + A1:2008 + A2:2010 (Radiated, radio-frequency, electromagnetic field test) EN 61000-4-4:2004 + A1:2010 (Burst Electrical fast transients/burst test) EN 61000-4-5:2006 (Surge test) EN 61000-4-6:2009 (to conducted disturbances, induced by radio- frequency fields) EN 61000-4-8:2010 (power frequency magnetic field test) EN 61000-6-2:2005 + B1:2011 (for industrial environments)
UL Certification	The device CIFX 50E-RE is certified according to UL 508.	UL-File-Nr. E221530
Configuration	Configuration Software Master and Slave	SYCON.net
	Configuration Software Slave	netX Configuration Tool

Table 92: Technical Data CIFX 50E-RE, CIFX 50E-RE\ET

10.1.14 CIFX 50E-DP

CIFX 50E-DP	Parameter	Value
Part	Name	CIFX 50E-DP
	Part No.	1251.410
	Description	PC Card cifX PCI Express PROFIBUS DP Master or Slave and PROFIBUS MPI Device
	Function	Communication interface with PCI Express and PROFIBUS interface
Communication Controller	Type	netX 100 processor
Integrated Memory	RAM	8 MB SDRAM
	FLASH	4 MB serial Flash EPROM
	Size of the Dual-Port Memory	64 KByte
System Interface	Bus Type	PCI Express, One Lane Port, according to [bus spec 2, Rev. 2.0] and [bus spec 3], refer to section <i>Overview</i> , page 107.
	Transmission Rate	2 GBit/s
	Data Access	DPM or DMA* (Direct Memory Access); *beginning from Hardware Revision 5
	Width for the data access to the Dual-Port Memory (DPM)	32-Bit
PROFIBUS Communication	Supported communication standard/ protocol (determined by the loaded firmware)	PROFIBUS DP Master, PROFIBUS DP Slave, PROFIBUS MPI Device
PROFIBUS Interface	Transmission rate	9,6 kBit/s, 19,2 kBit/s, 31,25 kBit/s, 45,45 kBit/s, 93,75 kBit/s, 187,5 kBit/s, 500 kBit/s, 1,5 MBit/s, 3 MBit/s, 6 MBit/s, 12 MBit/s
	Interface Type	RS 485, refer to section <i>PROFIBUS Interface</i> page 100.
	Galvanic Isolation	isolated
	Isolation Voltage	1000 VDC (tested for 1 minute)
	Connector	DSub female Connector, 9 pin
Display	LED Display	SYS System Status LED COM LED Communication Status (duo LED) The meaning of the COM LED depends on the loaded firmware. Refer to chapter <i>LED Descriptions</i> , page 78.
Power supply	Supply Voltage	+3,3 V dc $\pm 5\%$, refer to section <i>Power Supply and Host Interface</i> , page 33.
	Maximum Current at 3,3 V (typically)	800 mA
	Connector	Via PCI Express Bus
Operation	Rotary Switch Slot Number (Card ID)	To set the Slot Number (Card ID)
Environmental Conditions	Operating temperature range*	-20 °C ... +70 °C
	*Air flow during measurement	0,5m/s
	Storage temperature range	-10 °C ... +70 °C
	Humidity	10 ... 95% relative humidity, no condensation permitted
	Environment	For UL compliant usage: The device must be used in a pollution degree 2 environment.
Device	Dimensions (L x W x H)	120,0 x 86 x 18,5 mm (from hardware revision 5)
	Mounting/Installation	PCI Express x1 slot (3.3 V), refer to section <i>Slot for the PC Cards cifX PCI, PCIe and Low Profile PCIe</i> , page 32.

CIFX 50E-DP	Parameter	Value
	RoHS	Yes
CE Sign	CE Sign	Yes
	Emission	EN 55011:2009 + A1:2010, CISPR 11:2009, Class A (Radio disturbance characteristics - Limits and methods of measurement)
	Immunity	EN 61000-4-2:2009 (Electrostatic discharge test) EN 61000-4-3:2006 + A1:2008 + A2:2010 (Radiated, radio-frequency, electromagnetic field test) EN 61000-4-4:2004 + A1:2010 (Burst Electrical fast transients/burst test) EN 61000-4-5:2006 (Surge test) EN 61000-4-6:2009 (to conducted disturbances, induced by radio- frequency fields) EN 61000-4-8:2010 (power frequency magnetic field test) EN 61000-6-2:2005 + B1:2011 (for industrial environments)
UL Certification	The device is certified according to UL 508.	UL-File-Nr. E221530
Configuration	Configuration Software Master and Slave	SYCON.net
	Configuration Software Slave	netX Configuration Tool

Table 93: Technical Data CIFX 50E-DP

10.1.15 CIFX 50E-CO

CIFX 50E-CO	Parameter	Value
Part	Name	CIFX 50E-CO
	Part No.	1251.500
	Description	PC Card cifX PCI ExpressCANopen Master or Slave
	Function	Communication interface with PCI Express and CANopen interface
Communication Controller	Type	netX 100 processor
Integrated Memory	RAM	8 MB SDRAM
	FLASH	4 MB serial Flash EPROM
	Size of the Dual-Port Memory	64 KByte
System Interface	Bus Type	PCI Express, One Lane Port, according to [bus spec 2, Rev. 2.0] and [bus spec 3], refer to section <i>Overview</i> , page 107.
	Transmission Rate	2 GBit/s
	Data Access	DPM or DMA* (Direct Memory Access); *beginning from Hardware Revision 4
	Width for the data access to the Dual-Port Memory (DPM)	32-Bit
CANopen Communication	Supported communication standard/ protocol (determined by the loaded firmware)	CANopen Master, CANopen Slave
CANopen Interface	Transmission rate	10 kBit/s, 20 kBit/s, 50 kBit/s, 100 kBit/s, 125 kBit/s, 250 kBit/s, 500 kBit/s, 800 kBit/s, 1 MBit/s
	Interface Type	ISO-11898, refer to section <i>CANopen Interface</i> , page 100.
	Galvanic Isolation	optically isolated

CIFX 50E-CO	Parameter	Value
	Isolation Voltage	1000 VDC (tested for 1 minute)
	Connector	DSub female Connector, 9 pin
Display	LED Display	SYS System Status LED CAN CANopen Status (duo LED) The meaning of the CAN LED depends on the loaded firmware. Refer to chapter <i>LED Descriptions</i> , page 78.
Power supply	Supply Voltage	+3,3 V dc ±5 %, refer to section <i>Power Supply and Host Interface</i> , page 33.
	Maximum Current at 3,3 V (typically)	800 mA
	Connector	Via PCI Express Bus
Operation	Rotary Switch Slot Number (Card ID)	To set the Slot Number (Card ID)
Environmental Conditions	Operating temperature range*	-20 °C ... +70 °C
	*Air flow during measurment	0,5m/s
	Storage temperature range	-10 °C ... +70 °C
	Humidity	10 ... 95% relative humidity, no condensation permitted
	Environment	For UL compliant usage: The device must be used in a pollution degree 2 environment.
Device	Dimensions (L x W x H)	120,0 x 86 x 18,5 mm (from hardware revision 4)
	Mounting/Installation	PCI Express x1 slot (3.3 V), refer to section <i>Slot for the PC Cards cifX PCI, PCIe and Low Profile PCIe</i> , page 32.
	RoHS	Yes
CE Sign	CE Sign	Yes
	Emission	EN 55011:2009 + A1:2010, CISPR 11:2009, Class A (Radio disturbance characteristics - Limits and methods of measurement)
	Immunity	EN 61000-4-2:2009 (Electrostatic discharge test) EN 61000-4-3:2006 + A1:2008 + A2:2010 (Radiated, radio-frequency, electromagnetic field test) EN 61000-4-4:2004 + A1:2010 (Burst Electrical fast transients/burst test) EN 61000-4-5:2006 (Surge test) EN 61000-4-6:2009 (to conducted disturbances, induced by radio- frequency fields) EN 61000-4-8:2010 (power frequency magnetic field test) EN 61000-6-2:2005 + B1:2011 (for industrial environments)
UL Certification	The device is certified according to UL 508.	UL-File-Nr. E221530
Configuration	Configuration Software Master and Slave	SYCON.net
	Configuration Software Slave	netX Configuration Tool

Table 94: Technical Data CIFX 50E-CO

10.1.16 CIFX 50E-DN

CIFX 50E-DN	Parameter	Value
Part	Name	CIFX 50E-DN
	Part No.	1251.510
	Description	PC Card cifX PCI Express DeviceNet Master or Slave
	Function	Communication interface with PCI Express and DeviceNet interface
Communication Controller	Type	netX 100 processor
Integrated Memory	RAM	8 MB SDRAM
	FLASH	4 MB serial Flash EPROM
	Size of the Dual-Port Memory	64 KByte
System Interface	Bus Type	PCI Express, One Lane Port, according to [bus spec 2, Rev. 2.0] and [bus spec 3], refer to section <i>Overview</i> , page 107.
	Transmission Rate	2 GBit/s
	Data Access	DPM or DMA* (Direct Memory Access); *beginning from Hardware Revision 4
	Width for the data access to the Dual-Port Memory (DPM)	32-Bit
DeviceNet Communication	Supported communication standard/ protocol (determined by the loaded firmware)	DeviceNet Master, DeviceNet Slave
DeviceNet Interface	Transmission rate	125 kBit/s, 250 kBit/s, 500 kBit/s
	Interface Type	ISO-11898 according to DeviceNet specification, refer to section <i>DeviceNet Interface</i> , page 101.
	Galvanic Isolation	optically isolated
	Isolation Voltage	1000 VDC (tested for 1 minute)
	Connector	CombiCon male Connector, 5 pin
Display	LED Display	SYS System Status LED MNS Module Network Status (duo LED) The meaning of the MNS LED depends on the loaded firmware. Refer to chapter <i>LED Descriptions</i> , page 78..
Power supply	Supply Voltage	+3,3 V dc ±5 %, refer to section <i>Power Supply and Host Interface</i> , page 33.
	Maximum Current at 3,3 V (typically)	800 mA
	Connector	Via PCI Express Bus
Operation	Rotary Switch Slot Number (Card ID)	To set the Slot Number (Card ID)
Environmental Conditions	Operating temperature range*	-20 °C ... +70 °C
	*Air flow during measurement	0,5m/s
	Storage temperature range	-10 °C ... +70 °C
	Humidity	10 ... 95% relative humidity, no condensation permitted
	Environment	For UL compliant usage: The device must be used in a pollution degree 2 environment.
Device	Dimensions (L x W x H)	120,0 x 86 x 18,5 mm (from hardware revision 4)
	Mounting/Installation	PCI Express x1 slot (3.3 V), refer to section <i>Slot for the PC Cards cifX PCI, PCIe and Low Profile PCIe</i> , page 32.
	RoHS	Yes

CIFX 50E-DN	Parameter	Value
CE Sign	CE Sign	Yes
	Emission	EN 55011:2009 + A1:2010, CISPR 11:2009, Class A (Radio disturbance characteristics - Limits and methods of measurement)
	Immunity	EN 61000-4-2:2009 (Electrostatic discharge test) EN 61000-4-3:2006 + A1:2008 + A2:2010 (Radiated, radio-frequency, electromagnetic field test) EN 61000-4-4:2004 + A1:2010 (Burst Electrical fast transients/burst test) EN 61000-4-5:2006 (Surge test) EN 61000-4-6:2009 (to conducted disturbances, induced by radio- frequency fields) EN 61000-4-8:2010 (power frequency magnetic field test) EN 61000-6-2:2005 + B1:2011 (for industrial environments)
UL Certification	The device is certified according to UL 508.	UL-File-Nr. E221530
Configuration	Configuration Software Master and Slave	SYCON.net
	Configuration Software Slave	netX Configuration Tool

Table 95: Technical Data CIFX 50E-DN

10.1.17 CIFX 50E-2ASM

CIFX 50E-2ASM	Parameter	Value
Part	Name	CIFX 50E-2ASM
	Part No.	1253.630
	Description	PC Card cifX PCI Express2 channel AS-Interface Master
	Function	Communication interface with PCI Express and 2 x AS-Interface interface
Communication Controller	Type	netX 100 processor
Integrated Memory	RAM	8 MB SDRAM
	FLASH	4 MB serial Flash EPROM
	Size of the Dual-Port Memory	64 KByte
System Interface	Bus Type	PCI Express, One Lane Port, according to [bus spec 2, Rev. 2.0] and [bus spec 3], refer to section <i>Overview</i> , page 107.
	Transmission Rate	2 GBit/s
	Data Access	DPM or DMA* (Direct Memory Access); *beginning from Hardware Revision 4
	Width for the data access to the Dual-Port Memory (DPM)	32-Bit
AS-Interface Communication	Supported communication standard/ protocol (determined by the loaded firmware)	AS-Interface Master
AS-Interface Interface	Transmission rate	166,67 kBit/s
	Interface Type	2 *, acc. to IEC 364-4-41, refer to section <i>AS-Interface Interface</i> , page 101.
	Galvanic Isolation	optically isolated
	Isolation Voltage	1000 VDC (tested for 1 minute)
	Connector	CombiCon male Connector, 2 pin

CIFX 50E-2ASM	Parameter	Value
Display	LED Display	SYS System Status LED CH1 LED channel 1 (duo LED) CH2 LED channel 2 (duo LED) Refer to ch. <i>LED Descriptions</i> , p. 78.
Power supply	Supply Voltage	+3,3 V dc $\pm 5\%$, refer to section <i>Power Supply and Host Interface</i> , page 33.
	Maximum Current at 3,3 V (typically)	800 mA
	Connector	Via PCI Express Bus
Operation	Rotary Switch Slot Number (Card ID)	To set the Slot Number (Card ID)
Environmental Conditions	Operating temperature range*	0 °C ... +55 °C
	*Air flow during measurement	0,5m/s
	Storage temperature range	0 °C ... +70 °C
	Humidity	10 ... 95% relative humidity, no condensation permitted
	Environment	For UL compliant usage: The device must be used in a pollution degree 2 environment.
Device	Dimensions (L x W x H)	120 x 94,5 x 18,5 mm
	Mounting/Installation	PCI Express x1 slot (3.3 V), refer to section <i>Slot for the PC Cards cifX PCI, PCIe and Low Profile PCIe</i> , page 32.
	RoHS	Yes
CE Sign	CE Sign	Yes
	Emission	EN 55011:2009 + A1:2010, CISPR 11:2009, Class A (Radio disturbance characteristics - Limits and methods of measurement)
	Immunity	EN 61000-4-2:2009 (Electrostatic discharge test) EN 61000-4-3:2006 + A1:2008 + A2:2010 (Radiated, radio-frequency, electromagnetic field test) EN 61000-4-4:2004 + A1:2010 (Burst Electrical fast transients/burst test) EN 61000-4-5:2006 (Surge test) EN 61000-4-6:2009 (to conducted disturbances, induced by radio- frequency fields) EN 61000-4-8:2010 (power frequency magnetic field test) EN 61000-6-2:2005 + B1:2011 (for industrial environments)
UL Certification	The device is certified according to UL 508.	UL-File-Nr. E221530
Configuration	Configuration Software	SYCON.net

Table 96: Technical Data CIFX 50E-2ASM

10.1.18 CIFX 50E-CC

CIFX 50E-CC	Parameter	Value
Part	Name	CIFX 50E-CC
	Part No.	1251.740
	Description	PC Card cifX PCI ExpressCC-Link Slave
	Function	Communication interface with PCI Express and CC-Link interface
Communication Controller	Type	netX 100 processor
Integrated Memory	RAM	8 MB SDRAM
	FLASH	4 MB serial Flash EPROM
	Size of the Dual-Port Memory	64 KByte
System Interface	Bus Type	PCI Express, One Lane Port, according to [bus spec 2, Rev. 2.0] and [bus spec 3], refer to section <i>Overview</i> , page 107.
	Transmission Rate	2 GBit/s
	Data Access	DPM or DMA* (Direct Memory Access); *beginning from Hardware Revision 3
	Width for the data access to the Dual-Port Memory (DPM)	32-Bit
CC-Link Communication	Supported communication standard/ protocol (determined by the loaded firmware)	CC-Link Slave
CC-Link Interface	Transmission rate	156 kBit/s, 625 kBit/s, 2500 kBit/s, 5 MBit/s, 10 MBit/s
	Interface Type	RS-485, refer to section <i>CC-Link Interface</i> , page 102.
	Galvanic Isolation	optically isolated
	Isolation Voltage	1000 VDC (tested for 1 minute)
	Connector	CombiCon male Connector, 5 pin
Display	LED Display	SYS System Status LED L RUN LED L Run (Duo LED) L ERR LED L Error (Duo LED) Refer to chapter <i>LED Descriptions</i> , page 78.
Power supply	Supply Voltage	+3,3 V dc $\pm 5\%$, refer to section <i>Power Supply and Host Interface</i> , page 33.
	Maximum Current at 3,3 V (typically)	800 mA
	Connector	Via PCI Express Bus
Operation	Rotary Switch Slot Number (Card ID)	To set the Slot Number (Card ID)
Environmental Conditions	Operating temperature range*	0 °C ... +60 °C
	*Air flow during measurement	0,5m/s
	Storage temperature range	0 °C ... +70 °C
	Humidity	10 ... 95% relative humidity, no condensation permitted
	Environment	For UL compliant usage: The device must be used in a pollution degree 2 environment.
Device	Dimensions (L x W x H)	120 x 89,9 x 18,5 mm (from hardware revision 3)
	Mounting/Installation	PCI Express x1 slot (3.3 V), refer to section <i>Slot for the PC Cards cifX PCI, PCIe and Low Profile PCIe</i> , page 32.
	RoHS	Yes

CIFX 50E-CC	Parameter	Value
CE Sign	CE Sign	Yes
	Emission	EN 55011:2009 + A1:2010, CISPR 11:2009, Class A (Radio disturbance characteristics - Limits and methods of measurement)
	Immunity	EN 61000-4-2:2009 (Electrostatic discharge test) EN 61000-4-3:2006 + A1:2008 + A2:2010 (Radiated, radio-frequency, electromagnetic field test) EN 61000-4-4:2004 + A1:2010 (Burst Electrical fast transients/burst test) EN 61000-4-5:2006 (Surge test) EN 61000-4-6:2009 (to conducted disturbances, induced by radio- frequency fields) EN 61000-4-8:2010 (power frequency magnetic field test) EN 61000-6-2:2005 + B1:2011 (for industrial environments)
UL Certification	The device is certified according to UL 508.	UL-File-Nr. E221530
Configuration	Configuration Software	SYCON.net or netX Configuration Tool

Table 97: Technical Data CIFX 50E-CC

10.1.19 CIFX 70E-RE, CIFX 70E-RE\MR

CIFX 70E-RE, CIFX 70E-RE\MR	Parameter	Value	
Part	Name	CIFX 70E-RE	CIFX 70E-RE\MR
	Part No.	1.259.100	1.259.103
	Description	PC Card cifX Low Profile PCI Express Real-Time-Ethernet Master or Slave (Low Profile PCIe with RTE)	
	Function	Communication interface with PCI Express and Ethernet interface	
Communication Controller	Type	netX 100 processor	
Integrated Memory	RAM	8 MB SDRAM	
	FLASH	4 MB serial Flash EPROM	
	Size of the Dual-Port Memory	64 KByte	
	MRAM (only CIFX 70E-RE\MR)	128Kbyte (= 64K Words); Note: Using the cifX Device Driver (from Version 1.1.1.0) access to this memory is possible and it can be used as a remanent memory.	
System Interface	Bus Type	PCI Express, One Lane Port, according to [bus spec 2, Rev. 2.0] and [bus spec 3], refer to section <i>Overview</i> , page 107.	
	Transmission Rate	2 GBit/s	
	Data Access	DPM or DMA (Direct Memory Access)	
	Width for the data access to the Dual-Port Memory (DPM)	32-Bit	
Ethernet Communication	Supported Real-Time Ethernet communication systems (determined by the loaded firmware)	EtherCAT Master, EtherCAT Slave	
		EtherNet/IP Scanner (Master), EtherNet/IP Adapter (Slave),	
		Open Modbus/TCP	
		POWERLINK Controlled Node/Slave	
		PROFINET IO-Controller (Master), PROFINET IO-Device (Slave)	
		sercos Master, sercos Slave	
	VARAN Client (Slave)		
Ethernet Frame Types	Ethernet II		
Ethernet Interface	Transmission rate	100 MBit/s, 10 MBit/s (depending on loaded firmware)	
	Interface Type	100 BASE-TX, 10 BASE-T (depending on loaded firmware), refer to section <i>Ethernet Interface</i> , page 98.	
	Galvanic Isolation	isolated	
	Isolation Voltage	1000 VDC (tested for 1 minute)	
	Half duplex/Full duplex	depending on loaded firmware, supported (at 100 MBit/s)	
	Auto-Negotiation	depending on loaded firmware	
	Auto-Crossover	depending on loaded firmware	
	Connector	2* RJ45 Socket	
Channel 0 and 1	With loaded EtherCAT Master firmware only the RJ45 channel 0 can be used, channel 1 is deactivated. Beginning with the EtherCAT Master firmware version 3 channel 1 can be reactivated if redundancy is activated. For Open Modbus/TCP with V2.3.4.0 and higher both RJ45 channels can be used.		

CIFX 70E-RE, CIFX 70E-RE\MR	Parameter	Value
Display	LED Display	<p>SYS System Status LED</p> <p>The meaning of the following LEDs depends on the loaded firmware:</p> <p>COM 0 LED Communication Status 0 (duo LED)</p> <p>COM 1 LED Communication Status 1 (duo LED)</p> <p>LED yellow at RJ45Ch0 and RJ45Ch1, for Ethernet Link status, Ethernet Aktivität status and additional status</p> <p>LED green</p> <p>Refer to chapter <i>LED Descriptions</i>, page 78.</p>
Power supply	Supply Voltage	+3,3 V dc ±5 %, refer to section <i>Power Supply and Host Interface</i> , page 33.
	Maximum Current at 3,3 V (typically)	800 mA
	Connector	Via PCI Express Bus
Operation	Rotary Switch Slot Number (Card ID)	To set the Slot Number (Card ID)
Environmental Conditions	Operating temperature range*	0 °C ... +65 °C
	*Air flow during measurement	0,5m/s
	Storage temperature range	0 °C ... +70 °C
	Humidity	10 ... 95% relative humidity, no condensation permitted
	Environment	For UL compliant usage: The device must be used in a pollution degree 2 environment.
Device	Dimensions (L x W x H)	119,0 x 69,0 x 18,5 mm
	Mounting/Installation	PCI Express x4 slot (3.3 V), refer to section <i>Slot for the PC Cards cifX PCI, PCIe and Low Profile PCIe</i> , page 32.
	RoHS	Yes
CE Sign	CE Sign	Yes
	Emission	EN 55011:2009 + A1:2010, CISPR 11:2009, Class A (Radio disturbance characteristics - Limits and methods of measurement)
	Immunity	EN 61000-4-2:2009 (Electrostatic discharge test) EN 61000-4-3:2006 + A1:2008 + A2:2010 (Radiated, radio-frequency, electromagnetic field test) EN 61000-4-4:2004 + A1:2010 (Burst Electrical fast transients/burst test) EN 61000-4-5:2006 (Surge test) EN 61000-4-6:2009 (to conducted disturbances, induced by radio- frequency fields) EN 61000-4-8:2010 (power frequency magnetic field test) EN 61000-6-2:2005 + B1:2011 (for industrial environments)
UL Certification	The device CIFX 70E-RE is certified according to UL 508.	UL-File-Nr. E221530
Configuration	Configuration Software Master and Slave	SYCON.net
	Configuration Software Slave	netX Configuration Tool

Table 98: Technical Data CIFX 70E-RE, CIFX 70E-RE\MR

10.1.20 CIFX 100EH-RE\CUBE

CIFX 100EH-RE	Parameter	Value
Part	Name	CIFX 100EH-RE
	Part No.	9016.090
	Description	PC Card cifX PCI Express for Real-Time Ethernet Master or Slave, (low-profile card) exclusively for the installing in KEBA KeControl industry PCs series CP 3XX (Cube).
	Function	Communication interface with PCI Express and Ethernet interface
Communication Controller	Type	netX 100 processor
Integrated Memory	RAM	8 MB SDRAM
	FLASH	4 MB serial Flash EPROM
	Size of the Dual-Port Memory	64 KByte
System Interface	Bus Type	PCI Express, One Lane Port*, (refer to section <i>Overview</i> , page 107 and <i>Pin Assignment for PCI Express Bus CIFX 100EH-RE\CUBE</i> , page 108. *The PC card CIFX 100EH-RE\CUBE can be used for x4 connectors, but not a real x4 connection (mechanical deviation from the standard, it is used only 1 lane).
	Transmission Rate	2 GBit/s
	Data Access	DPM or DMA (Direct Memory Access)
	Width for the data access to the Dual-Port Memory (DPM)	32-Bit
Ethernet Communication	Supported Real-Time Ethernet communication systems (determined by the loaded firmware)	EtherCAT Master, EtherCAT Slave
		EtherNet/IP Scanner (Master), EtherNet/IP Adapter (Slave),
		Open Modbus/TCP
		POWERLINK Controlled Node/Slave
		PROFINET IO-Controller (Master), PROFINET IO-Device (Slave)
		sercos Master, sercos Slave
	VARAN Client (Slave)	
Ethernet Frame Types	Ethernet II	
Ethernet Interface	Transmission rate	100 MBit/s, 10 MBit/s (depending on loaded firmware)
	Interface Type	100 BASE-TX, 10 BASE-T (depending on loaded firmware), refer to section <i>Ethernet Interface</i> , page 98.
	Galvanic Isolation	isolated
	Isolation Voltage	1000 VDC (tested for 1 minute)
	Half duplex/Full duplex	depending on loaded firmware, supported (at 100 MBit/s)
	Auto-Negotiation	depending on loaded firmware
	Auto-Crossover	depending on loaded firmware
	Connector	2* RJ45 Socket
Channel 0 and 1	With loaded EtherCAT Master firmware only the RJ45 channel 0 can be used, channel 1 is deactivated. Beginning with the EtherCAT Master firmware version 3 channel 1 can be reactivated if redundancy is activated. For Open Modbus/TCP with V2.3.4.0 and higher both RJ45 channels can be used.	
Display	LED Display	SYS System Status LED

CIFX 100EH-RE	Parameter	Value
		<p>The meaning of the following LEDs depends on the loaded firmware:</p> <p>COM 0 LED Communication Status 0 (duo LED)</p> <p>COM 1 LED Communication Status 1 (duo LED)</p> <p>LED yellow at RJ45Ch0 and RJ45Ch1, for Ethernet Link status, Ethernet Aktivität status and additional status</p> <p>LED green at RJ45Ch0 and RJ45Ch1, for Ethernet Link status, Ethernet Aktivität status and additional status</p> <p>Refer to chapter <i>LED Descriptions</i>, page 78.</p>
Power supply	Supply Voltage	+3,3 V dc ±5 %, refer to section <i>Power Supply and Host Interface</i> , page 33.
	Maximum Current at 3,3 V (typically)	800 mA
	Connector	Via PCI Express Bus
Operation	Rotary Switch Slot Number (Card ID)	To set the Slot Number (Card ID)
Environmental Conditions	Operating temperature range*	0 °C ... +65 °C
	*Air flow during measurement	0,5m/s
	Storage temperature range	0 °C ... +70 °C
	Humidity	10 ... 95% relative humidity, no condensation permitted
	Environment	For UL compliant usage: The device must be used in a pollution degree 2 environment.
Device	Dimensions (L x W x H)	110,0 x 69,0 x 18,5 mm
	Mounting/Installation	PCI Express x4 slot (3.3 V), refer to section <i>Slot for the PC Cards cifX PCI, PCIe and Low Profile PCIe</i> , page 32. x4 ⁵ = Four Lane; In the PCI Express x4 slot only lane 0 is used. For further details refer to section <i>Pin Assignment for PCI Express Bus CIFX 100EH-RE\CUBE</i> on page 108.
	Master License	NXLIC Master (Part No 8211.000)
	RoHS	Yes
CE Sign	CE Sign	Yes
	Emission	EN 55011:2009 + A1:2010, CISPR 11:2009, Class A (Radio disturbance characteristics - Limits and methods of measurement)
	Immunity	EN 61000-4-2:2009 (Electrostatic discharge test) EN 61000-4-3:2006 + A1:2008 + A2:2010 (Radiated, radio-frequency, electromagnetic field test) EN 61000-4-4:2004 + A1:2010 (Burst Electrical fast transients/burst test) EN 61000-4-5:2006 (Surge test) EN 61000-4-6:2009 (to conducted disturbances, induced by radio- frequency fields) EN 61000-4-8:2010 (power frequency magnetic field test) EN 61000-6-2:2005 + B1:2011 (for industrial environments)
UL Certification	The device is certified according to UL 508.	UL-File-Nr. E221530
Configuration	Configuration Software Master and Slave	SYCON.net

⁵ The term "x4" refers to the convention of the PCI Express specifications [bus spec 3] to the number of lanes in the slot.

CIFX 100EH-RE	Parameter	Value
	Configuration Software Slave	netX Configuration Tool

Table 99: Technical Data CIFX 100EH-RE\CUBE

10.1.21 CIFX 70E-DP, CIFX 70E-DP\MR

CIFX 70E-DP, CIFX 70E-DP\MR	Parameter	Value
Part	Name	CIFX 70E-DP CIFX 70E-DP\MR
	Part No.	1259.410 1259.413
	Description	PC Card cifX Low Profile PCI Express PROFIBUS DP Master or Slave and PROFIBUS MPI Device (Low Profile PCIe with PROFIBUS)
	Function	Communication interface with PCI Express and PROFIBUS interface
Communication Controller	Type	netX 100 processor
Integrated Memory	RAM	8 MB SDRAM
	FLASH	4 MB serial Flash EPROM
	Size of the Dual-Port Memory	64 KByte
	MRAM (only CIFX 70E-DP\MR)	128Kbyte (= 64K Words); Note: Using the cifX Device Driver (from Version 1.1.1.0) access to this memory is possible and it can be used as a remanent memory.
System Interface	Bus Type	PCI Express, One Lane Port, according to [bus spec 2, Rev. 2.0] and [bus spec 3], refer to section <i>Overview</i> , page 107.
	Transmission Rate	2 GBit/s
	Data Access	DPM or DMA (Direct Memory Access)
	Width for the data access to the Dual-Port Memory (DPM)	32-Bit
PROFIBUS Communication	Supported communication standard/ protocol (determined by the loaded firmware)	PROFIBUS DP Master, PROFIBUS DP Slave, PROFIBUS MPI Device
PROFIBUS Interface	Transmission rate	9,6 kBit/s, 19,2 kBit/s, 31,25 kBit/s, 45,45 kBit/s, 93,75 kBit/s, 187,5 kBit/s, 500 kBit/s, 1,5 MBit/s, 3 MBit/s, 6 MBit/s, 12 MBit/s
	Interface Type	RS 485, refer to section <i>PROFIBUS Interface</i> , page 100.
	Galvanic Isolation	isolated
	Isolation Voltage	1000 VDC (tested for 1 minute)
	Connector	DSub female Connector, 9 pin
Display	LED Display	SYS System Status LED COM LED Communication Status (duo LED) The meaning of the COM LED depends on the loaded firmware. Refer to chapter <i>LED Descriptions</i> , page 78.
Power supply	Supply Voltage	+3,3 V dc \pm 5 %, refer to section <i>Power Supply and Host Interface</i> , page 33.
	Maximum Current at 3,3 V (typically)	800 mA
	Connector	Via PCI Express Bus
Operation	Rotary Switch Slot Number (Card ID)	To set the Slot Number (Card ID)
Environmental	Operating temperature range*	0 °C ... +65 °C

CIFX 70E-DP, CIFX 70E-DP\MR	Parameter	Value
Conditions	*Air flow during measurement	0,5m/s
	Storage temperature range	0 °C ... +70 °C
	Humidity	10 ... 95% relative humidity, no condensation permitted
	Environment	For UL compliant usage: The device must be used in a pollution degree 2 environment.
Device	Dimensions (L x W x H)	119,0 x 69,0 x 18,5 mm
	Mounting/Installation	PCI Express x1 slot (3.3 V), refer to section <i>Slot for the PC Cards cifX PCI, PCIe and Low Profile PCIe</i> , page 32.
	RoHS	Yes
CE Sign	CE Sign	Yes
	Emission	EN 55011:2009 + A1:2010, CISPR 11:2009, Class A (Radio disturbance characteristics - Limits and methods of measurement)
	Immunity	EN 61000-4-2:2009 (Electrostatic discharge test) EN 61000-4-3:2006 + A1:2008 + A2:2010 (Radiated, radio-frequency, electromagnetic field test) EN 61000-4-4:2004 + A1:2010 (Burst Electrical fast transients/burst test) EN 61000-4-5:2006 (Surge test) EN 61000-4-6:2009 (to conducted disturbances, induced by radio- frequency fields) EN 61000-4-8:2010 (power frequency magnetic field test) EN 61000-6-2:2005 + B1:2011 (for industrial environments)
UL Certification	The device CIFX 70E-DP is certified according to UL 508.	UL-File-Nr. E221530
Configuration	Configuration Software Master and Slave	SYCON.net
	Configuration Software Slave	netX Configuration Tool

Table 100: Technical Data CIFX 70E-DP, CIFX 70E-DP\MR

10.1.22 CIFX 70E-CO, CIFX 70E-CO\MR

CIFX 70E-CO, CIFX 70E-CO\MR	Parameter	Value
Part	Name	CIFX 70E-CO CIFX 70E-CO\MR
	Part No.	1259.500 1259.503
	Description	PC-Karte cifX Low Profile PCI Express CANopen Master bzw. Slave (Low Profile PCIe mit CANopen)
	Function	Communication interface with PCI Express and CANopen interface
Communication Controller	Type	netX 100 processor
Integrated Memory	RAM	8 MB SDRAM
	FLASH	4 MB serial Flash EPROM
	Size of the Dual-Port Memory	64 KByte
	MRAM (only CIFX 70E-CO\MR)	128Kbyte (= 64K Words); Note: Using the cifX Device Driver (from Version 1.1.1.0) access to this memory is possible and it can be used as a remanent memory.
System Interface	Bus Type	PCI Express, One Lane Port, according to [bus spec 2,

CIFX 70E-CO, CIFX 70E-CO\MR	Parameter	Value
		Rev. 2.0] and [bus spec 3], refer to section <i>Overview</i> , page 107.
	Transmission Rate	2 GBit/s
	Data Access	DPM or DMA (Direct Memory Access)
	Width for the data access to the Dual-Port Memory (DPM)	32-Bit
CANopen Communication	Supported communication standard/ protocol (determined by the loaded firmware)	CANopen Master, CANopen Slave
CANopen Interface	Transmission rate	10 kBit/s, 20 kBit/s, 50 kBit/s, 100 kBit/s, 125 kBit/s, 250 kBit/s, 500 kBit/s, 800 kBit/s, 1 MBit/s
	Interface Type	ISO-11898, refer to section <i>CANopen Interface</i> , page 100.
	Galvanic Isolation	optically isolated
	Isolation Voltage	1000 VDC (tested for 1 minute)
	Connector	DSub female Connector, 9 pin
Display	LED Display	SYS System Status LED CAN CANopen Status (duo LED)
		The meaning of the CAN LED depends on the loaded firmware. Refer to chapter <i>LED Descriptions</i> , page 78.
Power supply	Supply Voltage	+3,3 V dc ±5 %, refer to section <i>Power Supply and Host Interface</i> , page 33.
	Maximum Current at 3,3 V (typically)	800 mA
	Connector	Via PCI Express Bus
Operation	Rotary Switch Slot Number (Card ID)	To set the Slot Number (Card ID)
Environmental Conditions	Operating temperature range*	0 °C ... +65 °C
	*Air flow during measurement	0,5m/s
	Storage temperature range	0 °C ... +70 °C
	Humidity	10 ... 95% relative humidity, no condensation permitted
	Environment	For UL compliant usage: The device must be used in a pollution degree 2 environment.
Device	Dimensions (L x W x H)	119,0 x 69,0 x 18,5 mm
	Mounting/Installation	PCI Express x1 slot (3.3 V), refer to section <i>Slot for the PC Cards cifX PCI, PCIe and Low Profile PCIe</i> , page 32.
	RoHS	Yes
CE Sign	CE Sign	Yes
	Emission	EN 55011:2009 + A1:2010, CISPR 11:2009, Class A (Radio disturbance characteristics - Limits and methods of measurement)
	Immunity	EN 61000-4-2:2009 (Electrostatic discharge test) EN 61000-4-3:2006 + A1:2008 + A2:2010 (Radiated, radio-frequency, electromagnetic field test) EN 61000-4-4:2004 + A1:2010 (Burst Electrical fast transients/burst test) EN 61000-4-5:2006 (Surge test) EN 61000-4-6:2009 (to conducted disturbances, induced by radio- frequency fields) EN 61000-4-8:2010 (power frequency magnetic field test) EN 61000-6-2:2005 + B1:2011 (for industrial

CIFX 70E-CO, CIFX 70E-CO\MR	Parameter	Value
		environments)
UL Certification	The device CIFX 70E-CO is certified according to UL 508.	UL-File-Nr. E221530
Configuration	Configuration Software Master and Slave	SYCON.net
	Configuration Software Slave	netX Configuration Tool

Table 101: Technical Data CIFX 70E-CO, CIFX 70E-CO\MR

10.1.23 CIFX 70E-DN, CIFX 70E-DN\MR

CIFX 70E-DN, CIFX 70E-DN\MR	Parameter	Value
Part	Name	CIFX 70E-DN CIFX 70E-DN\MR
	Part No.	1259.510 1259.513
	Description	PC Card cifX Low Profile PCI Express DeviceNet Master or Slave (Low Profile PCIe with DeviceNet)
	Function	Communication interface with PCI Express and DeviceNet interface
Communication Controller	Type	netX 100 processor
Integrated Memory	RAM	8 MB SDRAM
	FLASH	4 MB serial Flash EPROM
	Size of the Dual-Port Memory	64 KByte
	MRAM (only CIFX 70E-DN\MR)	128Kbyte (= 64K Words); Note: Using the cifX Device Driver (from Version 1.1.1.0) access to this memory is possible and it can be used as a remanent memory.
System Interface	Bus Type	PCI Express, One Lane Port, according to [bus spec 2, Rev. 2.0] and [bus spec 3], refer to section <i>Overview</i> , page 107.
	Transmission Rate	2 GBit/s
	Data Access	DPM or DMA (Direct Memory Access)
	Width for the data access to the Dual-Port Memory (DPM)	32-Bit
DeviceNet Communication	Supported communication standard/ protocol (determined by the loaded firmware)	DeviceNet Master, DeviceNet Slave
DeviceNet Interface	Transmission rate	125 kBit/s, 250 kBit/s, 500 kBit/s
	Interface Type	ISO-11898 according to DeviceNet specification, refer to section <i>DeviceNet Interface</i> , page 101.
	Galvanic Isolation	optically isolated
	Isolation Voltage	1000 VDC (tested for 1 minute)
	Connector	CombiCon male Connector, 5 pin
Display	LED Display	SYS System Status LED MNS Module Network Status (duo LED) The meaning of the MNS LED depends on the loaded firmware. Refer to chapter <i>LED Descriptions</i> , page 78.
Power supply	Supply Voltage	+3,3 V dc ±5 %, refer to section <i>Power Supply and Host Interface</i> , page 33.
	Maximum Current at 3,3 V (typically)	800 mA
	Connector	Via PCI Express Bus

CIFX 70E-DN, CIFX 70E-DN\MR	Parameter	Value
Operation	Rotary Switch Slot Number (Card ID)	To set the Slot Number (Card ID)
Environmental Conditions	Operating temperature range*	0 °C ... +65 °C
	*Air flow during measurement	0,5m/s
	Storage temperature range	0 °C ... +70 °C
	Humidity	10 ... 95% relative humidity, no condensation permitted
	Environment	For UL compliant usage: The device must be used in a pollution degree 2 environment.
Device	Dimensions (L x W x H)	119,0 x 69,0 x 18,5 mm
	Mounting/Installation	PCI Express x1 slot (3.3 V), refer to section <i>Slot for the PC Cards cifX PCI, PCIe and Low Profile PCIe</i> , page 32.
	RoHS	Yes
CE Sign	CE Sign	Yes
	Emission	EN 55011:2009 + A1:2010, CISPR 11:2009, Class A (Radio disturbance characteristics - Limits and methods of measurement)
	Immunity	EN 61000-4-2:2009 (Electrostatic discharge test) EN 61000-4-3:2006 + A1:2008 + A2:2010 (Radiated, radio-frequency, electromagnetic field test) EN 61000-4-4:2004 + A1:2010 (Burst Electrical fast transients/burst test) EN 61000-4-5:2006 (Surge test) EN 61000-4-6:2009 (to conducted disturbances, induced by radio- frequency fields) EN 61000-4-8:2010 (power frequency magnetic field test) EN 61000-6-2:2005 + B1:2011 (for industrial environments)
UL Certification	The device CIFX 70E-DN is certified according to UL 508.	UL-File-Nr. E221530
Configuration	Configuration Software Master and Slave	SYCON.net
	Configuration Software Slave	netX Configuration Tool

Table 102: Technical Data CIFX 70E-DN, CIFX 70E-DNMR

10.2 PCI IDs PC Cards cifX on the PCI Bus

On the PCI bus the PC Cards cifX have the following PCI IDs:

PCI IDs	Value
VendorID	0x15CF
DeviceID	0x0000
Subsystem Vendor ID	0x0000
Subsystem Device ID	0x0000

Table 103: PCI IDs PC Cards cifX on the PCI Bus

10.3 Supported PCI-Bus Commands

From the following table you can see which PCI bus commands are supported by the Hilscher PC Cards cifX *PCI*, *PCI Express* and *Low Profile PCI Express*.

C/BE3#	C/BE2#	C/BE1#	C/BE0#	Command Type	supported
0	0	0	0	Interrupt Acknowledge	no
0	0	0	1	Special Cycle	no
0	0	1	0	I/O Read	✓
0	0	1	1	I/O Write	✓
0	1	0	0	Reserved	no
0	1	0	1	Reserved	no
0	1	1	0	Memory Read	✓
0	1	1	1	Memory Write	✓
1	0	0	0	Reserved	no
1	0	0	1	Reserved	no
1	0	1	0	Configuration Read	✓
1	0	1	1	Configuration Write	✓
1	1	0	0	Memory Read Multiple	no
1	1	0	1	Dual Address Cycle	no
1	1	1	0	Memory Read Line	no
1	1	1	1	Memory Write and Invalidate	no

Table 104: Supported / not supported PCI Bus Commands

C/BE = Bus Command and Byte Enable Signal of PCI

10.4 Technical Data of the Communication Protocols

10.4.1 EtherCAT Master

Parameter	Description
Maximum number of EtherCAT slaves	Maximum 200 Slaves. The number of usable slaves depends on the available memory for the configuration file. See 'configuration file' below.
Maximum number of cyclic input data	5760 bytes
Maximum number of cyclic output data	5760 bytes
Minimum bus cycle time	205 μ s, depending on the used number of slaves and the used number of cyclic input data and output data. Recommended is a cycle time of 1 ms and higher.
Acyclic communication	CoE (CANopen over EtherCAT) CoE-Upload, CoE-Download Maximum 1500 bytes
Functions	Get OD List Get object description Get entry description Emergency Slave diagnostics
Bus Scan	Supported
Redundancy	Supported, but not at the same time with Distributed Clocks
Distributed Clocks	Supported, but not at the same time with Redundancy
Topology	Line or ring
Baud rate	100 MBit/s
Data transport layer	Ethernet II, IEEE 802.3
Configuration File (ethercat.xml or config.nxd)	PC cards PCI, PCI Express, PCI Express Low Profile, Mini PCI, Compact PCI, Mini PCI Express, PCI-104 Real-Time Ethernet: Maximum 1 MByte PC cards PC/104 Real-Time Ethernet: Maximum 2 MByte
Limitations	The size of the bus configuration file is limited by the size of the RAM Disk (1 Mbyte) or FLASH disk (2 Mbyte). All CoE Uploads, Downloads and information services must fit in one TLR-Packet. Fragmentation is not supported Distubuted Clock and Redundancy can not be used at the same time.
Reference to firmware/stack version	V3.0.x.x

Table 105: Technical Data EtherCAT Master Protocol

10.4.2 EtherCAT Slave

Parameter	Description
Maximum number of cyclic input data	256* bytes
Maximum number of cyclic output data	256* bytes
Acyclic communication	SDO SDO Master-Slave SDO Slave-Slave (depending on Master capability)
Type	Complex Slave
Functions	Emergency
FMMUs	3
SYNC Manager	4
Distributed Clocks (DC)	Supported, 32 Bit
Baud rate	100 MBit/s
Data transport layer	Ethernet II, IEEE 802.3
Limitation	LRW is not supported
Reference to firmware/stack version	V2.5.x.x and V4.2.x.x

Table 106: Technical Data EtherCAT Slave Protocol



Note: * The loadable firmware supports for the number of cyclic input data and for cyclic output data in total up to 512 bytes. If more than 256 bytes for input data or for output data shall be exchanged via EtherCAT, then a customer specific XML file is necessary. Additionally the following formula applies: The sum of the input data length and the output data length may not exceed 512 bytes, where each length has to be rounded up to the next multiple of 4 for this calculation.

10.4.3 EtherNet/IP Scanner (Master)

Parameter	Description
Maximum number of EtherNet/IP connections	64 connections for implicit and explicit
Maximum number of total cyclic input data	5712 bytes
Maximum number of total cyclic output data	5760 bytes
Maximum number of cyclic input data	504 bytes per slave per telegram
Maximum number of cyclic output data	504 bytes per slave per telegram
IO Connection type	Cyclic, minimum 1 ms (depending on used number of connections and used number of input and output data)
Maximum number of unscheduled data	1400 bytes per telegram
UCMM, Class 3	Supported
Explicit Messages, Client and Server Services	Get_Attribute_Single/All Set_Attribute_Single/All
Quick connect	Supported
Predefined standard objects	Identity Object Message Route Object Assembly Object Connection Manager Ethernet Link Object TCP/IP Object DLR Object QoS Object
Maximal number of user specific objects	20
Topology	Tree, Line, Ring
DLR (Device Level Ring)	Beacon based 'Ring Node'
ACD (Address Conflict Detection)	Supported
DHCP	Supported
BOOTP	Supported
Baud rates	10 and 100 MBit/s
Data transport layer	Ethernet II, IEEE 802.3
Switch function	Integrated
Limitations	CIP Sync Services are not implemented TAGs are not supported
Reference to firmware/stack version	V2.6.x.x

Table 107: Technical Data EtherNet/IP Scanner (Master) Protocol

10.4.4 EtherNet/IP Adapter (Slave)

Parameter	Description
Maximum number of input data	504 bytes
Maximum number of output data	504 bytes
IO connection types (implicit)	1 exclusive owner, 1 listen only, 1 input only
IO Connection trigger types	Cyclic, minimum 1 ms* Application Triggered, minimum 1 ms* Change Of State, minimum 1 ms* * depending on number of connections and number of input and output data
Explicit Messages	Connected and unconnected
Maximum number of connections	8, explicit and implicit connections
Unconnected Message Manager (UCMM)	Supported
Quick connect	Supported
Predefined standard objects	Identity Object Message Route Object Assembly Object Connection Manager DLR Object QoS Object TCP/IP Object Ethernet Link Object
Reset services	Identity Object Reset Service of Type 0 and 1
Maximum number of user specific objects	20
DLR V2 (ring topology)	Supported
ACD (Address Conflict Detection)	Supported
DHCP	Supported
BOOTP	Supported
Baud rates	10 and 100 MBit/s
Duplex modes	Half duplex, Full duplex, Auto negotiation
MDI modes	MDI, MDI-X, Auto-MDIX
Data transport layer	Ethernet II, IEEE 802.3
Switch function	Integrated
Limitations	CIP Sync Services are not implemented TAGs are not supported
Reference to firmware/stack version	V2.7.x.x

Table 108: Technical Data EtherNet/IP Adapter (Slave) Protocol

10.4.5 Open Modbus/TCP

Parameter	Description
Maximum number of input data	2880 Registers
Maximum number of output data	2880 Registers
Acyclic communication	Read/Write Register: - Maximum 125 Registers per Read Telegram (FC 3, 4, 23), - Maximum 121 Registers per Write Telegram (FC 23), - Maximum 123 Registers per Write Telegram (FC 16) Read/Write Coil: - Maximum 2000 Coils per Read Telegram (FC 1, 2), - Maximum 1968 Coils per Write Telegram (FC 15)
Modbus Function Codes	1, 2, 3, 4, 5, 6, 7, 15, 16, 23* * Function Code 23 can be used via the packet API, but not with the Command Table.
Protocol Mode	Message Mode (Client Mode): - Client (using the Command Table: The data is stored in the I/O process data image) - Client (using the packet API: The I/O process data image is not used) - Server (using the packet API: The I/O process data image is not used) I/O Mode (Server Mode): - Server (only) (The data is stored in the I/O process data image)
Baud rates	10 and 100 MBit/s
Data transport layer	Ethernet II, IEEE 802.3
Reference to firmware/stack version	V2.5.x.x

Table 109: Technical Data Open Modbus/TCP Protocol

10.4.6 POWERLINK Controlled Node/Slave

Parameter	Description
Maximum number of cyclic input data	1490 bytes
Maximum number of cyclic output data	1490 bytes
Acyclic data transfer	SDO Upload/Download
Functions	SDO over ASND and UDP
Baud rate	100 MBit/s, half-duplex
Data transport layer	Ethernet II, IEEE 802.3
Ethernet POWERLINK version	V 2
Limitation	No slave to slave communication
Reference to firmware/stack version	V2.1.x.x

Table 110: Technical Data POWERLINK Controlled Node (Slave) Protocol

10.4.7 PROFINET IO-Controller

Parameter	Description
Maximum number of PROFINET IO Devices	128
Maximum number of total cyclic input data	5712 bytes (including IOxS status bytes)
Maximum number of total cyclic output data	5760 bytes (including IOxS status bytes)
Maximum number of cyclic input data	1440 bytes per device (= IOCR data length including IOxS status bytes)
Maximum number of cyclic output data	1440 bytes per device (= IOCR data length including IOxS status bytes)
Acyclic communication	Read/Write Record Limited to 1392 bytes per telegram Limited to 4096 bytes per request
Alarm processing	yes, but requires handling in host application program
Diagnostic data	One 200 byte buffer per IO device
DCP functions via API	Name Assignment IO-Devices (DCP SET NameOfStation) Set IO-Devices IP (DCP SET IP) Signal IO-Device (DCP SET SIGNAL) Reset IO-Device to factory settings (DCP Reset FactorySettings) Bus scan (DCP IDENTIFY ALL)
Supported Protocols	RTC – Real Time Cyclic Protocol, Class 1 RTA – Real Time Acyclic Protocol DCP – Discovery and configuration Protocol CL-RPC – Connectionless Remote Procedure Call
Context management by CL-RPC	Supported
Minimum cycle time	1 ms Different IO-Devices can be configured with different cycle times
Functions	Fast Startup of PROFINET IO Devices supported
Baud rate	100 MBit/s Full-Duplex mode
Data transport layer	Ethernet II, IEEE 802.3
Configuration file	Maximum 1 MByte
Limitations	RT over UDP not supported Multicast communication not supported DHCP is not supported (neither for PROFINET IO-Controller nor for the IO-Devices) Only one IOCR per IO Device NameOfStation of IO Controller CANNOT be set using the DCP SET NameOfStation service but only at start-up while configuring the IO Controller The buffer for IO-Device diagnosis data will be overwritten in case of multiple diagnostic events. Only one (the last) event is stored at the same time. If a single event produces more than 200 bytes of diagnosis data, only the first 200 bytes will be taken care of. The usable (minimum) cycle time depends on the number of used IO Devices, the number of used input and output data. The cycle-time, the number of configured IO Devices and the amount of IO data depend on each other. For example it is not possible due to performance reasons to have 128 IO Devices communication with cycle-time 1ms. The size of the bus configuration file is limited by the size of the RAM Disk (1 MByte) WriteMultiple-Record service is not supported

Parameter	Description
Reference to firmware/stack version	V2.6.x.x

Table 111: Technical Data PROFINET IO RT Controller

10.4.8 PROFINET IO-Device (V3.4)

Parameter	Description
Maximum number of cyclic input data	1024 bytes
Maximum number of cyclic output data	1024 bytes
Acyclic communication	Read/Write Record, max. 1024 bytes per telegram
Alarm Types	Process Alarm, Diagnostic Alarm, Return of SubModule Alarm Plug Alarm (implicit), Pull Alarm (implicit)
Supported protocols	RTC – Real Time Cyclic Protocol, Class 1 and 2 (unsynchronized), Class 3 (synchronized) RTA – Real Time Acyclic Protocol DCP – Discovery and configuration Protocol CL-RPC – Connectionless Remote Procedure Call LLDP – Link Layer Discovery Protocol SNMP – Simple Network Management Protocol MRP – MRP Client
Used Protocols (subset)	UDP, IP, ARP, ICMP (Ping)
Topology recognition	LLDP, SNMP V1, MIB2, physical device
VLAN- and priority tagging	yes
Context Management by CL-RPC	Supported
Identification & Maintenance	Read and write of I&M1-4
Minimum cycle time	1 ms for RTC1 and RTC2 250 µs for RTC3
Baud rate	100 MBit/s
Data transport layer	Ethernet II, IEEE 802.3
Limitations	RT over UDP not supported Multicast communication not supported Only one device instance is supported DHCP is not supported IRT “flex” (synchronized RT Class 2) is not supported FastStartUp is not supported. Media Redundancy (except MRP client) is not supported Access to the submodule granular status bytes (IOCS) is not supported. The amount of configured IO-data influences the minimum cycle time that can be reached. Supervisor-AR is not supported, Supervisor-DA-AR is supported Only 1 Input-CR and 1 Output-CR are supported Multiple WriteRequests are not supported Using little endian (LSB-MSB) byte order for cyclic process data instead of default big endian (MSB-LSB) byte order may have a negative impact on minimum reachable cycle time
Reference to firmware/stack version	V3.4.x.x

Table 112: Technical Data PROFINET IO RT IRT Device Protocol

10.4.9 PROFINET IO Device (V3.5)

Parameter	Description
Maximum number of cyclic input data	1440 bytes
Maximum number of cyclic output data	1440 bytes
Maximum number of submodules	255 submodules per Application Relation at the same time, 1000 submodules can be configured
Multiple Application Relations (AR)	The Stack can handle up to 2 IO-ARs, one Supervisor AR and one Supervisor-DA AR at the same time
Acyclic communication	Read/Write Record, max. 1024 bytes per telegram
Alarm Types	Process Alarm, Diagnostic Alarm, Return of SubModule Alarm, Plug Alarm (implicit), Pull Alarm (implicit)
Supported protocols	RTC – Real Time Cyclic Protocol, class 1 (unsynchronized), class 3 (synchronized) RTA – Real Time Acyclic Protocol DCP – Discovery and configuration Protocol CL-RPC – Connectionless Remote Procedure Call LLDP – Link Layer Discovery Protocol SNMP – Simple Network Management Protocol MRP – MRP Client
Topology recognition	LLDP, SNMP V1, MIB2, physical device
Identification & Maintenance	Read and write of I&M1-4
Minimum cycle time	1 ms for RT_CLASS_1 250 µs for RT_CLASS_3
IRT Support	RT_CLASS_3
Media Redundancy	MRP client is supported
Additional features	DCP, VLAN- and priority tagging, Shared Device
Baud rate	100 MBit/s
Data transport layer	Ethernet II, IEEE 802.3
PROFINET IO specification	V2.2 (legacy startup) and V2.3 (but advanced startup only for RT) are supported
Limitations	RT over UDP not supported Multicast communication not supported Only one device instance is supported DHCP is not supported FastStartUp is not supported The amount of configured IO-data influences the minimum cycle time that can be reached. Only 1 Input-CR and 1 Output-CR are supported Using little endian (LSB-MSB) byte order for cyclic process data instead of default big endian (MSB-LSB) byte order may have a negative impact on minimum reachable cycle time System Redundancy (SR-AR) and Configuration-in-Run (CiR) are not supported Max. 255 submodules can be used simultaneously within one specific Application Relation Advanced Startup according Profinet specification V2.3 is NOT yet supported for IRT As there is no official certification available for Profinet IO specification V2.3 at the time of release of the stack there is no guarantee that this implementation will pass such a certification once it is available
Reference to firmware/stack version	V3.5.26.x

Table 113: Technical Data PROFINET IO RT IRT Device Protocol

10.4.10 sercos Master

Parameter	Description
Maximum number of cyclic input data	5760 bytes (including Connection Control per Connection)
Maximum number of cyclic output data	5760 bytes (including Connection Control per Connection)
Maximum number of configured slave devices	511
Minimum cycle time	250 µs
Acyclic communication	Service channel: Read/Write/Commands
Functions	Bus Scan
Communication phases	NRT, CP0, CP1, CP2, CP3, CP4
Topology	Line and double ring
Redundancy	supported
NRT channel	supported
Hot-Plug	supported
Cross Communication	supported, but only if the master is configured by the host application program by packets.
Baud rate	100 MBit/s, full duplex
Data transport layer	Ethernet II, IEEE 802.3
Auto crossover	supported
Supported sercos version	Communication Specification Version 1.3
TCP/IP stack	integrated
Reference to firmware/stack version	V2.1.x.x

Table 114: Technical Data sercos Master Protocol

10.4.11 sercos Slave

Parameter	Description
Maximum number of cyclic input data (Tx) of all slaves	128 bytes (including Connection Control and IO Status)
Maximum number of cyclic output data (Rx) of all slaves	128 bytes (including Connection Control and IO Status)
Maximum number of slave devices	8
Maximum number of applicable sercos addresses	1 ... 511
Minimum cycle time	250 µs
Topology	Line and ring
Communication phases	NRT, CP0, CP1, CP2, CP3, CP4
Acyclic Communication (Service Channel)	Read/Write/Standard Commands
Baud rate	100 MBit/s
Data transport layer	Ethernet II, IEEE 802.3
Supported sercos version	sercos in the third generation Communication Specification Version 1.1.2
Supported sercos Communication Profiles	SCP_FixCFG Version 1.1.1 SCP_VarCFG Version 1.1.1 SCP_VarCFG Version 1.1.3
Supported User SCP Profiles	SCP_WD Version 1.1.1 SCP_Diag Version 1.1.1 SCP_RTb Version 1.1.1 SCP_Mux Version 1.1.1 SCP_Sig Version 1.1.1 SCP_ExtMuX Version 1.1.2 SCP_RTbListProd Version 1.3 SCP_RTbListCons Version 1.3 SCP_RTbWordProd Version 1.3 SCP_RTbWordCons Version 1.3 SCP_OvSBasic Version 1.3 SCP_WDCon Version 1.3
Supported FSP profiles	FSP_IO FSP_Drive
SCP Sync	Supported
SCP_NRT	Supported
S/IP	Supported
Identification LED	Supported
Storage location of object dictionary	Mixed mode
Limitations	Max. 2 connections: 1 for consumer and 1 for producer Modifications of the Service-Channel Object Dictionary will be volatile after reset (if it resides on device) Hot plug is not supported yet Cross communication not supported yet
Reference to firmware/stack version	V3.1.x.x

Table 115: Technical Data sercos Slave Protocol

10.4.12 VARAN Client (Slave)

Parameter	Description
Maximum number of cyclic input data	128 bytes
Maximum number of cyclic output data	128 bytes
Memory Area	Read Memory Area 1, Write Memory Area 1
Functions	Memory Read Memory Write
Integrated 2 port splitter for daisy chain topology	Supported
Baud rate	100 MBit/s
Data transport layer	Ethernet II, IEEE 802.3
VARAN protocol version	1.1.1.0
Limitations	Integrated EMAC for IP data exchange with client application not supported SPI single commands (optional feature) not supported Memory area 2 is not supported.
Reference to firmware/stack version	V1.0.x.x

Table 116: Technical Data VARAN Client Protocol

10.4.13 PROFIBUS DP Master

Parameter	Description
Maximum number of PROFIBUS DP slaves	125 (DPV0/DPV1)
Maximum number of total cyclic input data	5712 bytes
Maximum number of total cyclic output data	5760 bytes
Maximum number of cyclic input data	244 bytes per slave
Maximum number of cyclic output data	244 bytes per slave
Configuration data	Max. 244 bytes per slave
Parameterization data per slave	7 bytes standard parameter per slave Max. 237 bytes application specific parameters per slave
Acyclic communication	DPV1 class 1 read, write DPV1 class 1 alarm DPV1 class 2 initiate, read, write, data transport, abort
Maximum number of acyclic read/write	240 bytes per slave and telegram
Functions	Configuration in Run (CiR), requires host application program support Timestamp (Master functionality)
Redundancy	Supported, requires host application program support
Baud rate	9,6 kBits/s, 19,2 kBits/s, 31,25 kBits/s, 45,45 kBits/s 93,75 kBits/s, 187,5 kBits/s, 500 kBits/s, 1, 5 MBits/s, 3 MBits/s, 6 MBits/s, 12 MBit/s Auto baud rate detection is not supported
Data transport layer	PROFIBUS FDL
Limitations	DPV2 isochronous mode and slave slave communication are not supported. The redundancy function can not be used, if the master is configured by the host application program by packets.
Reference to firmware/stack version	V2.6.x.x

Table 117: Technical Data PROFIBUS DP Master Protocol

10.4.14 PROFIBUS DP Slave

Parameter	Description
Maximum number of cyclic input data	244 bytes
Maximum number of cyclic output data	244 bytes
Maximum number of acyclic data (read/write)	240 bytes/telegram
Maximum number of modules	24
Configuration data	Max. 244 bytes
Parameter data	237 bytes application specific parameters
Acyclic communication	DP V1 Class 1 Read/Write DP V1 Class 1 Alarm DP V1 Class 2 Read/Write/Data Transport
Baud rate	9,6 kBits/s, 19,2 kBits/s, 31,25 kBits/s, 45,45 kBits/s, 93,75 kBits/s, 187,5 kBits/s, 500 kBits/s, 1, 5 MBits/s, 3 MBits/s, 6 MBits/s, 12 MBit/s Auto baudrate detection is supported
Data transport layer	PROFIBUS FDL
Limitations	SSCY1S – Slave to slave communication state machine not implemented Data exchange broadcast not implemented I&M LR services other than Call-REQ/RES are not supported yet
Reference to firmware/stack version	V2.7.x.x

Table 118: Technical Data PROFIBUS DP Slave Protocol

10.4.15 PROFIBUS MPI

Parameter	Description
Maximum number of MPI connections	126
Maximum number of write data	216 bytes
Maximum number of read data	222 bytes
Functions	MPI Read/Write DB (data block), M (marker), Q (output), C (Counter), T (Timer) MPI Read I (Input) Data type bit to access to DB (data block), M (marker), Q (output) and I (Input, read only) MPI Connect (automatically when first read/write function is used) MPI Disconnect, MPI Disconnect All MPI Get OP Status MPI transparent (expert use only)
Baud rate	Fixed values ranging from 9,6 kBits/s to 12 MBit/s Auto-detection mode is supported
Data transport layer	PROFIBUS FDL
Reference to firmware/stack version	2.4.x.x

Table 119: Technical Data PROFIBUS-MPI Protocol

10.4.16 CANopen Master

Parameter	Description
Maximum number of CANopen nodes	126
Maximum number of cyclic input data	3584 bytes
Maximum number of cyclic output data	3584 bytes
Maximum number of receive PDOs	512
Maximum number of transmit PDOs	512
Exchange of process data	Via PDO transfer: - synchronized, - remotely requested and - event driven (change of date)
Acyclic communication	SDO Upload/Download, max. 512 bytes per request
Functions	Emergency message (consumer and producer) Node guarding / life guarding, heartbeat PDO mapping NMT Master SYNC protocol (producer) Simple boot-up process, reading object 1000H for identification
Baud rates	10 kBits/s, 20 kBits/s, 50 kBits/s, 100 kBits/s, 125 kBits/s, 250 kBits/s, 500 kBits/s, 800 kBits/s, 1 MBits/s
CAN layer 2 access	Send/receive via API supported (11 bit/29 bit)
Data transport layer	CAN Frames
CAN Frame type for CANopen	11 Bit
Reference to version	V2.11.x.x

Table 120: Technical Data CANopen Master Protocol

10.4.17 CANopen Slave

Parameter	Description
Maximum number of cyclic input data	512 bytes
Maximum number of cyclic output data	512 bytes
Maximum number of receive PDOs	64
Maximum number of transmit PDOs	64
Exchange of process data	Via PDO transfer - synchronized, - remotely requested and - event driven (change of date, event timer) On request of the host application program by packet
Acyclic communication	SDO upload/download (server only) Emergency message (producer) Timestamp (producer/consumer)
Functions	Node guarding / life guarding Heartbeat: 1 producer, max. 64 consumer PDO mapping NMT Slave SYNC protocol (consumer) Error behaviour (configurable): - in state operational: change to state pre-operational - in any state: no state change - in state operational or pre-operational: change to state stopped
Baud rates	10 kBits/s, 20 kBits/s, 50 kBits/s, 100 kBits/s, 125 kBits/s, 250 kBits/s, 500 kBits/s, 800 kBits/s, 1 MBits/s Auto baudrate detection is supported
CAN layer 2 access	Send/receive via API supported (11 bit/29 bit)
Data transport layer	CAN Frames
CAN Frame type for CANopen	11 Bit
Reference to firmware/stack version	V3.6.x.x

Table 121: Technical Data CANopen Slave Protocol

10.4.18 DeviceNet Master

Parameter	Description
Maximum number of DeviceNet slaves	63
Maximum number of total cyclic input data	3584 bytes
Maximum number of total cyclic output data	3584 bytes
Maximum number of cyclic input data	255 bytes/connection
Maximum number of cyclic output data	255 bytes/connection
Maximum Configuration data	1000 bytes/slave
Acyclic communication	Explicit connection All service codes are supported
Connections	Bit Strobe Change of State Cyclic Poll Explicit Peer-to-Peer Messaging
Function	Quick Connect
Fragmentation	Explicit and I/O
UCMM	Supported
Objects	Identity Object (Class Code 0x01) Message Router Object (Class Code 0x02) DeviceNet Object (Class Code 0x03) Connection Object (Class Code 0x05) Acknowledge Handler Object (Class Code 0x06)
Baud rates	125 kBits/s, 250 kBit/s, 500 kBit/s Auto baudrate detection is not supported
Data transport layer	CAN frames
Reference to firmware/stack version	V2.3.x.x

Table 122: Technical Data DeviceNet Master Protocol

10.4.19 DeviceNet Slave

Parameter	Description
Maximum number of cyclic input data	255 bytes
Maximum number of cyclic output data	255 bytes
Acyclic communication	Get_Attribute_Single/All Max. 240 bytes per request Set_Attribute_Single/All Max. 240 bytes per request
Connections	Poll Change-of-state Cyclic Bit-strobe
Explicit messaging	Supported
Fragmentation	Explicit and I/O
UCMM	Not supported
Baud rates	125 kBits/s, 250 kBit/s, 500 kBit/s Auto baudrate detection is not supported
Data transport layer	CAN frames
Reference to firmware/stack version	V2.3.x.x

Table 123: Technical Data DeviceNet Slave Protocol

10.4.20 AS-Interface Master

Parameter	Description
Maximum number of supported slaves	Max. 62 slaves
Maximum number of total cyclic input data	Max. 248 bits using digital slaves Max. 248 bytes using analog (transparent) slaves The maximum number depends on the used slave profiles
Maximum number of total cyclic output data	Max. 248 bits using digital slaves Max. 248 bytes using analog (transparent) slaves The maximum number depends on the used slave profiles
Maximum number of cyclic input data	Max. 4 Bit digital data Max. 4 channel with up to 16 bit analog data The maximum number depends on the used slave profiles
Maximum number of cyclic output data	Max. 4 Bit digital data Max. 4 channel with up to 16 bit analog data The maximum number depends on the used slave profiles
Parameterization data	4 bit per standard slave 3 bit per extended slave
Maximum number of acyclic read/write	Max. 220 bytes for string transfer
Functions	Support of data exchange via combined transaction types 1, 2, 3, 4 and 5 (CTT 1-5) Automatic address assignment Modification of address and Extended ID1-Code of Slave supported Profile for extended Master: M4
Baud rate	166,67 kBaud
AS-Interface specification	3.0 Revision 2
Limitations	'Synchronous Data I/O Mode' not supported
Reference to firmware/stack version	V2.3.x.x

Table 124: Technical Data AS-Interface Master Protocol

10.4.21 CC Link Slave

Parameter	Description
Firmware works according to CC-Link Version 2.0:	
Station Types	Remote Device Station (up to 4 occupied stations)
Maximum input data	368 bytes
Maximum output data	368 bytes
Input data remote device station	112 bytes (RY) and 256 bytes (RWw)
Output data remote device station	112 bytes (RX) and 256 bytes (RWr)
Extension cycles	1, 2, 4, 8
Baud rates	156 kBit/s, 625 kBit/s, 2500 kBit/s, 5 MBit/s, 10 MBit/s
Limitation	Intelligent Device Station not supported
Firmware works according to CC-Link Version 1.11:	
Station Types	Remote I/O station, Remote device station' (up to 4 occupied stations)
Maximum input data	48 bytes
Maximum output data	48 bytes
Input data remote I/O station	4 bytes (RY)
Output data remote I/O station	4 bytes (RX)
Input data remote device station	4 bytes (RY) and 8 bytes (RWw) per occupied station
Output data remote device station	4 bytes (RX) and 8 bytes (RWr) per occupied station
Baud rates	156 kBit/s, 625 kBit/s, 2500 kBit/s, 5 MBit/s, 10 MBit/s
Firmware	
Reference to firmware/stack version	V2.9.x.x

Table 125: Technical Data CC-Link-Slave Protocol

11 Annex

11.1 Matrix Label

A matrix label is on the device. It contains 3 items:

1. Part number
2. Hardware Revision
3. Serial number

The figure shows part number 1250.100, hardware revision 3 and serial number 23456.

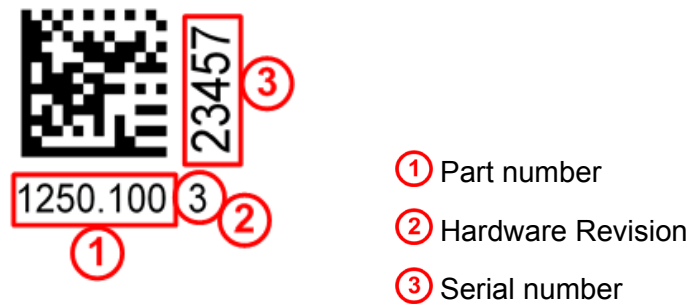

Figure 55: Matrix Label

11.2 EtherCAT Summary over Vendor ID, Conformance test, Membership and Network Logo

11.2.1 Vendor ID

The communication interface product is shipped with Hilscher's secondary vendor ID, which has to be replaced by the Vendor ID of the company shipping end products with the integrated communication interface. End Users or Integrators may use the communication interface product without further modification if they re-distribute the interface product (e.g. PCI Interface card products) only as part of a machine or machine line or as spare part for such a machine. In case of questions, contact Hilscher and/or your nearest ETG representative. The ETG Vendor-ID policies apply.

11.2.2 Conformance

EtherCAT Devices have to conform to the EtherCAT specifications. The EtherCAT Conformance Test Policies apply, which can be obtained from the EtherCAT Technology Group (ETG, www.ethercat.org).

Hilscher range of embedded network interface products are conformance tested for network compliance. This simplifies conformance testing of the end product and can be used as a reference for the end product as a statement of network conformance (when used with standard operational settings). It must however be clearly stated in the product documentation that this applies to the network interface and not to the complete product.

Conformance Certificates can be obtained by passing the conformance test in an official EtherCAT Conformance Test lab. Conformance Certificates are not mandatory, but may be required by the end user.

11.2.3 Certified Product vs. Certified Network Interface

The EtherCAT implementation may in certain cases allow one to modify the behavior of the EtherCAT network interface device in ways which are not in line with EtherCAT conformance requirements. For example, certain communication parameters are set by a software stack, in which case the actual software implementation in the device application determines whether or not the network interface can pass the EtherCAT conformance test. In such cases, conformance test of the end product must be passed to ensure that the implementation does not affect network compliance.

Generally, implementations of this kind require in-depth knowledge in the operating fundamentals of EtherCAT. To find out whether or not a certain type of implementation can pass conformance testing and requires such testing, contact EtherCAT Technology Group ("ETG", www.ethercat.org) and/or your nearest EtherCAT conformance test centre. EtherCAT may allow the combination of an untested end product with a conformant network interface. Although this may in some cases make it possible to sell the end product without having to perform network conformance tests, this approach is generally not endorsed by Hilscher. In case of questions, contact Hilscher and/or your nearest ETG representative.

11.2.4 Membership and Network Logo

Generally, membership in the network organization and a valid Vendor-ID are prerequisites in order to be able to test the end product for conformance. This also applies to the use of the EtherCAT name and logo, which is covered by the ETG marking rules.

Vendor ID Policy accepted by ETG Board of Directors, November 5, 2008

11.3 Notes on earlier Hardware Revisions

11.3.1 Failure in 10 MBit/s Half Duplex Mode and Workaround

The note is only valid for the PC cards cifX up to serial numbers indicated:

PC Cars cifX	Part No	up to Serial Number
CIFX 50-RE	1250.100	22414
CIFX 50E-RE	1251.100	20167

NOTICE

Failure of the Network Communication

- Do not operate hardware with the communication controllers netX 50, netX100 or netX 500 with the protocols Ethernet TCP/UDP/IP, EtherNet/IP or Modbus TCP at 10 MBit/s in half-duplex mode, otherwise failure of the network communication can occur.
- Use only switches or 10/100 MBit/s dual-speed hubs and ensure that the network operates at 100 MBit/s and in full-duplex mode.

Affected Hardware

Hardware with the communication controller netX 50, netX 100 or netX 500; netX/Internal PHYs.

When can this Failure occur?

When using standard Ethernet communication with 10 MBit/s half duplex mode, the PHY gets stuck in case of network collisions. Then no further network communication is possible. Only device power cycling allows Ethernet communication again.

This problem can only occur with Ethernet TCP/UDP IP, EtherNet/IP or Modbus TCP protocols when using hubs at 10 MBit/s. The issue described above is not applicable for protocols which use 100 MBit/s or full duplex mode.

Solution / Workaround:

Do not use 10 MBit/s-only hubs. Use either switches or 10/100 MBit/s Dual Speed hubs, to make sure the netX Ethernet ports are connected with 100 MBit/s or in full duplex mode.

This erratum is fixed with all components of the 'Y' charge (9 digit charge number shows 'Y' at position 5 (nnnnYnnnn)).

Reference

"Summary of 10BT problem on EthernetPHY",
RenesasElectronics Europe, April 27, 2010

11.4 Disposal of Waste Electronic Equipment

According to the European Directive 2002/96/EG “Waste Electrical and Electronic Equipment (WEEE)”, waste electronic equipment may not be disposed of as household waste. As a consumer, you are legally obliged to dispose of all waste electronic equipment according to national and local regulations.



Waste Electronic Equipment

- This product must not be treated as household waste.
- This product must be disposed of at a designated waste electronic equipment collecting point.

11.5 References

- [1] THE CIP NETWORKS LIBRARY, Volume 6, CompoNet Adaptation of CIP, Edition 1.4 November 2008
- [2] Data sheet MOD JACK – MJIM:
<https://www.erni-x-press.com/de/downloads/zeichnungen/203313.pdf>
- [3] Design - Specification for VARAN Rev. 0.76, section 5.1.4 VARAN Splitter

References Protocol API Manuals
• AS-Interface Master Protocol API Manual, Revision 4, Hilscher GmbH 2012
• CANopen Master Protocol API Manual, Revision 14, Hilscher GmbH 2013
• CANopen Slave Protocol API Manual (V3), Revision 5, Hilscher GmbH 2013
• CC-Link Slave Protocol API Manual, Revision 8, Hilscher GmbH 2013
• CompoNet Slave Protocol API Manual, Revision 2, Hilscher GmbH 2010
• DeviceNet Master Protocol API Manual, Revision 10, Hilscher GmbH 2013
• DeviceNet Slave Protocol API Manual, Revision 13, Hilscher GmbH 2013
• EtherCAT Master Protocol API Manual (V3), Revision 5, Hilscher GmbH 2013
• EtherCAT Slave Protocol API Manual, Revision 3 (V4), Hilscher GmbH 2013
• EtherCAT Slave Protocol API Manual, Revision 21 (V2), Hilscher GmbH 2013
• EtherNet/IP Scanner Protocol API Manual, Revision 13, Hilscher GmbH 2013
• EtherNet/IP Adapter Protocol API Manual, Revision 12, Hilscher GmbH 2013
• Open Modbus/TCP Protocol API Manual, Revision 8, Hilscher GmbH 2013
• POWERLINK Controlled Node/Slave Protocol API Manual, Revision 12, Hilscher GmbH 2013
• PROFIBUS DP Master Protocol API Manual, Revision 18, Hilscher GmbH 2013
• PROFIBUS DP Slave Protocol API Manual, Revision 15, Hilscher GmbH 2013
• PROFIBUS MPI Protocol API Manual, Revision 4, Hilscher GmbH 2011
• PROFINET IO-Controller Protocol API Manual, Revision 18, Hilscher GmbH 2013
• PROFINET IO-Device Protocol API Manual (V3.4), Revision 13, Hilscher GmbH 2013
• PROFINET IO-Device Protocol API Manual (V3.5), Revision 6, Hilscher GmbH 2013
• sercos Master Protocol API Manual, Revision 11, Hilscher GmbH 2013
• sercos Slave Protocol API Manual (V3), Revision 12, Hilscher GmbH 2013
• VARAN Client Protocol API Manual, Revision 3, Hilscher GmbH 2013

Table 126: References Protocol API Manuals

References referring to the safety issues are listed separately in section *References Safety* on page 25. References referring to the Standard Bus Specifications for PCI and PCI Express are listed separately *References PCI Specifications* on page 107.

11.6 List of Figures

Figure 1: System Overview cifX to update Firmware, Driver and Software	42
Figure 2: CIFX 50-RE* (from hardware rev. 3), CIFX 50-RE\ET* (from hardware rev. 1)	43
Figure 3: CIFX 50E-RE* (from hardware rev. 4), CIFX 50E-RE\ET* (from hardware rev. 1)	43
Figure 4: Front Plate for CIFX 50-RE, CIFX 50-RE\ET, CIFX 50E-RE or CIFX 50E-RE\ET	44
Figure 5: CIFX 50-DP (hardware revision 5)*	45
Figure 6: CIFX 50E-DP (hardware revision 5)*	45
Figure 7: Front Plate CIFX 50-DP or CIFX 50E-DP	46
Figure 8: CIFX 50-2DP (Hardware Revision 3)	47
Figure 9: Front Plate CIFX 50-2DP	47
Figure 10: CIFX 50-2DP\CO (Hardware Revision 2)	48
Figure 11: Front Plate CIFX 50-2DP\CO	48
Figure 12: CIFX 50-2DP\DN (Hardware Revision 1)	49
Figure 13: Front Plate CIFX 50-2DP\DN	49
Figure 14: CIFX 50-CO (hardware revision 5)	50
Figure 15: CIFX 50E-CO (from hardware revision 4)	50
Figure 16: Front Plate for CIFX 50-CO or CIFX 50E-CO	51
Figure 17: CIFX 50-2CO (Hardware Revision 2)	52
Figure 18: Front Plate CIFX 50-2CO	52
Figure 19: CIFX 50-2 CO\DN (Hardware Revision 1)	53
Figure 20: Front Plate CIFX 50-2CO\DN	53
Figure 21: CIFX 50-DN (hardware revision 5)	54
Figure 22: CIFX 50E-DN (from hardware revision 4)	54
Figure 23: Front Plate CIFX 50-DN or CIFX 50E-DN	55
Figure 24: CIFX 50-2DN (Hardware Revision 2)	56
Figure 25: Front Plate CIFX 50-2DN	56
Figure 26: CIFX 50-2ASM (hardware revision 2)	57
Figure 27: CIFX 50E-2ASM (from hardware revision 2)	57
Figure 28: Front Plate CIFX 50-2ASM	58
Figure 29: CIFX 50-CC (hardware revision 2)*	59
Figure 30: CIFX 50E-CC (hardware revision 4)*	59
Figure 31: Front Plate CIFX 50-CC or CIFX 50E-CC	60
Figure 32: CIFX 70E-RE* (Hardware revision 1)	61
Figure 33: CIFX 70E-RE\MR* (Hardware revision 1)	61
Figure 34: Front Plate for CIFX 70E-RE, CIFX 70E-RE\MR	62
Figure 35: CIFX 100EH-RE\CUBE*	63
Figure 36: Front Plate CIFX 100EH-RE\CUBE	63
Figure 37: CIFX 70E-DP (Hardware revision 1)	64
Figure 38: CIFX 70E-DP\MR (Hardware revision 1)	64
Figure 39: Front Plate CIFX 70E-DP, CIFX 70E-DP\MR	65
Figure 40: CIFX 70E-CO (Hardware revision 1)	66
Figure 41: CIFX 70E-CO\MR (Hardware revision 1)	66
Figure 42: Front Plate CIFX 70E-CO, CIFX 70E-CO\MR	67
Figure 43: CIFX 70E-DN (Hardware revision 1)	68
Figure 44: CIFX 70E-DN\MR (Hardware revision 1)	68
Figure 45: Front Plate CIFX 70E-DN, CIFX 70E-DN\MR	69
Figure 46: Front Plate Stickers for CIFX 50-RE, CIFX 50-RE\ET, CIFX 50E-RE or CIFX 50E-RE\ET	72
Figure 47: Front Plate Stickers for CIFX 70E-RE, CIFX 70E-RE\MR	74
Figure 48: Front Plate Stickers for CIFX 100EH-RE\CUBE	74
Figure 49: Ethernet Pin Assignment at the RJ45 Socket for cifX or AIFX	98
Figure 50: PROFIBUS Interface (DSub female connector, 9 pin), X400	100
Figure 51: CANopen Interface (DSub male connector, 9 pin), X400	100

Figure 52: DeviceNet Interface (CombiCon male Connector, 5 pin), X360	101
Figure 53: AS-Interface Interface (CombiCon male Connector, 2 pin)	101
Figure 54: CC-Link Interface (CombiCon male Connector, 5 pin)	102
Figure 55: Matrix Label	168

11.7 List of Tables

Table 1: List of Revisions	8
Table 2: Reference on Hardware PC Cards cifX	9
Table 3: Reference on Driver and Software	10
Table 4: Reference on Firmware (for 1 Channel Systems)	10
Table 5: Reference on Firmware (for 2 Channel Systems)	11
Table 6: PROFINET IO-Device Firmware Version 3.4 and 3.5, Header, GSDML and Protocol API Manual	14
Table 7: EtherCAT-Slave Firmware Version 2.5 and 4.2, Header, XML and Protocol API Manual	15
Table 8: Device Description Files for PC Cards cifX	16
Table 9: PC Cards cifX and the Real-Time Ethernet or Fieldbus Systems realized thereby	21
Table 10: Signal Words and Safety Signa in Safety Messages on Personal Injury	25
Table 11: Signal Words and Safety Signa in Safety Messages on Property Damage	25
Table 12: PC Cards PCI CIFX 50-XX	26
Table 13: PC Cards PCI (2 Channels) CIFX 50-2XX, CIFX 50-2XX\XX	27
Table 14: PC Cards PCI Express CIFX 50E-XX, CIFX 70E-XX	28
Table 15: Firmware Versions for the Function Slot Number (Card I), (for 1 Channel Systems)	29
Table 16: Firmware Versions for the Function Slot Number (Card ID) (for 2 Channel Systems)	29
Table 17: Versions Driver, Bootloader and SYCON.net for Function Slot Number (Card ID)	29
Table 18: Firmware Versions for the DMA Mode (for 1 Channel Systems)	30
Table 19: Firmware Versions for the DMA Mode (for 2 Channel Systems)	31
Table 20: Versions Driver and SYCON.net for the DMA Mode	31
Table 21: Slot for the PC Cards cifX PCI, PCIe and Low Profile PCIe	32
Table 22: Requirements Power Supply and Host Interface for PC Cards cifX PCI, PCIe Low Profile PCIe	33
Table 23: Requirements to operate PC Cards cifX properly	34
Table 24: Steps for the Software and Hardware Installation, the Configuration and for the Diagnosis of a PC Card cifX (Master and Slave)	38
Table 25: Notes for the Configuration of the Master Device	39
Table 26: Device Names in SYCON.net by Communication Protocol	41
Table 27: LED Labeling depending of the loaded Firmware	72
Table 28: Fix Front Plate Sticker at the CIFX 70E-RE, CIFX 70E-RE\MR or CIFX 100EH-RE\CUBE	73
Table 29: LED Labeling depending of the loaded Firmware	74
Table 30: Overview LEDs Real-Time Ethernet Systems	78
Table 31: Overview LEDs by Fieldbus System	79
Table 32: System Status LED	79
Table 33: LEDs EtherCAT Master	80
Table 34: LED State Definition for EtherCAT Master for the RUN and ERR LEDs	80
Table 35: LEDs EtherCAT Slave	81
Table 36: LED State Definition for EtherCAT Slave for the RUN and ERR LEDs	81
Table 37: LEDs EtherNet/IP Scanner (Master)	82
Table 38: LEDs EtherNet/IP Adapter (Slave)	83
Table 39: LEDs Open Modbus/TCP	84
Table 40: LEDs POWERLINK Controlled Node Controlled Node/Slave	85
Table 41: LED State Definition for POWERLINK Controlled Node Controlled Node/Slave for the BS/BE LEDs	85
Table 42: LEDs PROFINET IO-Controller	86

Table 43: LEDs PROFINET IO-Device	87
Table 44: LEDs sercos Master	88
Table 45: LED State Definition for sercos Master for the STA and ERR LEDs	88
Table 46: LEDs sercos Slave	89
Table 47: LED State Definition for sercos Slave for the S3 LED	90
Table 48: LEDs VARAN Client	90
Table 49: LED State Definition for VARAN Client for the RUN and ERR LEDs	90
Table 50: LEDs PROFIBUS DP Master – 1 Communication Status LED (current Hardware Revision)	91
Table 51: LEDs PROFIBUS DP Slave – 1 Communication Status LED (current Hardware Revision)	91
Table 52: LEDs PROFIBUS MPI	92
Table 53: LEDs CANopen Master – 1 Communication Status LED (current Hardware Revision)	93
Table 54: LED State Definition for CANopen Master for the CAN LED	93
Table 55: LEDs CANopen Slave – 1 Communication Status LED (current Hardware Revision)	94
Table 56: LED State Definition for CANopen Slave for the CAN LED	94
Table 57: LEDs DeviceNet Master	95
Table 58: LED State Definition for DeviceNet Master for the MNS LED	95
Table 59: LEDs DeviceNet Slave	96
Table 60: LED State Definition for DeviceNet Slave for the MNS LED	96
Table 61: LEDs AS Interface Master	97
Table 62: LEDs CC-Link Slave	97
Table 63: Ethernet Pin Assignment at the RJ45 Socket for cifX or AIFX	98
Table 64: Ethernet Connection Data	99
Table 65: Use of Hubs and Switches	99
Table 66: PROFIBUS Interface, X400	100
Table 67: CANopen Interface, X400	100
Table 68: DeviceNet Interface, X360	101
Table 69: AS-Interface Interface	101
Table 70: CC-Link Interface	102
Table 71: Rotary Switch for Slot Number (Card ID), S1	103
Table 72: Rotary Switch Slot Number (Card ID) PC Cards cifX Low Profile PCI Express	104
Table 73: Pin Assignment for SYNC Connector, X51	105
Table 74: Pin Assignment for SYNC Connector, J1	105
Table 75: SYNC Connector: SYNC Signal, Connector, Max. Cable Length	106
Table 76: Meaning of the SYNC Signals for each Protocol	106
Table 77: Pin Assignment at the PCI Bus	107
Table 78: References PCI Specifications	107
Table 79: Pin Assignment for PCI Express-Bus CIFX 100EH-RE\CUBE	108
Table 80: Technical Data CIFX 50-RE, CIFX 50-RE\ET	110
Table 81: Technical Data CIFX 50-DP	112
Table 82: Technical Data CIFX 50-2DP	113
Table 83: Technical Data CIFX 50-2DP\CO	115
Table 84: Technical Data CIFX 50-2DP\DN	117
Table 85: Technical Data CIFX 50-CO	118
Table 86: Technical Data CIFX 50-2CO	119
Table 87: Technical Data CIFX 50-2CO\DN	121
Table 88: Technical Data CIFX 50-DN	122
Table 89: Technical Data CIFX 50-2DN	124
Table 90: Technical Data CIFX 50-2ASM	125
Table 91: Technical Data CIFX 50-CC	127
Table 92: Technical Data CIFX 50E-RE, CIFX 50E-RE\ET	129
Table 93: Technical Data CIFX 50E-DP	131
Table 94: Technical Data CIFX 50E-CO	132
Table 95: Technical Data CIFX 50E-DN	134

Table 96: Technical Data CIFS 50E-2ASM	135
Table 97: Technical Data CIFS 50E-CC	137
Table 98: Technical Data CIFS 70E-RE, CIFS 70E-RE\MR	139
Table 99: Technical Data CIFS 100EH-RE\CUBE	142
Table 100: Technical Data CIFS 70E-DP, CIFS 70E-DP\MR	143
Table 101: Technical Data CIFS 70E-CO, CIFS 70E-CO\MR	145
Table 102: Technical Data CIFS 70E-DN, CIFS 70E-DN\MR	146
Table 103: PCI IDs PC Cards cifX on the PCI Bus	147
Table 104: Supported / not supported PCI Bus Commands	147
Table 105: Technical Data EtherCAT Master Protocol	148
Table 106: Technical Data EtherCAT Slave Protocol	149
Table 107: Technical Data EtherNet/IP Scanner (Master) Protocol	150
Table 108: Technical Data EtherNet/IP Adapter (Slave) Protocol	151
Table 109: Technical Data Open Modbus/TCP Protocol	152
Table 110: Technical Data POWERLINK Controlled Node (Slave) Protocol	152
Table 111: Technical Data PROFINET IO RT Controller	154
Table 112: Technical Data PROFINET IO RT IRT Device Protocol	154
Table 113: Technical Data PROFINET IO RT IRT Device Protocol	155
Table 114: Technical Data sercos Master Protocol	156
Table 115: Technical Data sercos Slave Protocol	157
Table 116: Technical Data VARAN Client Protocol	158
Table 117: Technical Data PROFIBUS DP Master Protocol	159
Table 118: Technical Data PROFIBUS DP Slave Protocol	160
Table 119: Technical Data PROFIBUS-MPI Protocol	161
Table 120: Technical Data CANopen Master Protocol	162
Table 121: Technical Data CANopen Slave Protocol	163
Table 122: Technical Data DeviceNet Master Protocol	164
Table 123: Technical Data DeviceNet Slave Protocol	165
Table 124: Technical Data AS-Interface Master Protocol	166
Table 125: Technical Data CC-Link-Slave Protocol	167
Table 126: References Protocol API Manuals	171

11.8 Glossary

10-Base T

Standard for communication on Ethernet over twisted pair lines with RJ45 connectors and a [Baud rate](#) of 10 MBit/s (according to the IEEE 802.3 specification).

100-Base TX

Standard for communication on Ethernet over unshielded twisted pair lines with RJ45 connectors and a baud rate of 100 MBit/s according to the IEEE 802. specification

Auto-Crossover

Auto-Crossover is a feature of an interface: An interface with Auto-Crossover capability will automatically detect and correct if the data lines have been exchanged vice versa.

Auto-Negotiation

Auto-Negotiation is a feature of an interface: An interface with Auto-Negotiation will automatically determine a set of correct communication parameters.

Baud rate

Data transmission speed of a communication channel or interface.

Boot loader

Program loading the firmware into the memory of a device in order to be executed.

cifX

Communication InterFace based on netX

cifX TCP/IP Server

cifX TCP Server.exe

Program for the remote diagnostics via Ethernet.

Name: **cifX TCP/IP Server for SYCON.net**

User Interface: **TCP/IP Server for cifX**

Coil

A coil is a single bit in the memory that can be accessed using Modbus: read or write access with FC 1, 5, 15. Depending on the used Modbus function code a single coil or several coils lying in succession can be accessed.

CSP

electronic device data sheet, required for each CC-Link device

Device Description File

A file containing configuration information about a device being a part of a network that can be read out by masters for system configuration. Device Description Files use various formats which depend on the communication system.

DHCP

Dynamic Host Configuration Protocol

This is a protocol simplifying the configuration of IP networks by automatically assigning IP addresses.

Discrete Input

A "Discrete Input" (as defined in the Modbus terminology) is a single bit in the memory which can be accessed using Modbus (read with FC 2).

DP

Decentral Periphery

DPM

Dual-Port Memory

EDS

Electronic Data Sheet

EDS file

A special kind of Device Description File used for example by EtherNet/IP.

ET

Extended Temperature Range (Operating Temperature)

PC cards cifX with the addition of "ET" at the end of the part name can be used in an extended operating temperature range. Details to the operating temperature range are given in the technical data to the respective card.

EtherCAT

A communication system for industrial Ethernet designed and developed by Beckhoff Automation GmbH.

Ethernet

A networking technology used both for office and industrial communication via electrical or optical connections. It has been developed and specified by the Intel, DEC and XEROX. It provides data transmission with collision control and allows various protocols. As Ethernet is not necessarily capable for real-time application, various real-time extensions have been developed.

EtherNet/IP

A communication system for industrial Ethernet designed and developed by Rockwell. It partly uses the CIP (Common Industrial Protocol).

EtherNet/IP Scanner

A Scanner exchanges real-time I/O data with Adapters and Scanners. This type of node can respond to connection requests and can also initiate connections on its own.

EtherNet/IP Adapter

An Adapter emulates functions provided by traditional rack-adapter products. This type of node exchanges real-time I/O data with a Scanner Class product. It does not initiate connections on its own.

Ethernet POWERLINK

A communication system for industrial Ethernet designed and developed by B&R. It partly uses CANopen technologies.

FDL

Fieldbus Data Link defines the PROFIBUS communication on layer 2, identical for DP and FMS

Firmware

Software running inside a device providing the basic functionality of this device. The firmware is stored remanently in the flash memory circuit of the device. It can be updated by a firmware download.

Full duplex

Full duplex denominates a telecommunication system between two communication partners which allows simultaneous communication in both directions is called a full-duplex telecommunication system. At such a system, it will be possible to transmit data even if currently data are received. Full-duplex is the opposite of Half_duplex.

Function code

A function code (FC) is a standardized method to access, i. e. read or write on coils (Bits) or registers via Modbus.

Modbus function codes are elements of Modbus request/reply telegrams.

GSD

Generic Station Description, Device description file

GSD file

A special kind of Device Description File used by PROFIBUS (GSD = Generic Station Description).

GSDML

Generic Station Description Markup Language

XML based device description file.

GSDML file

A special kind of XML-based Device Description File used by PROFINET.

Half duplex

Half duplex denominates a telecommunication system between two communication partners which does not allow simultaneous, but alternating, communication in both directions is called a half-duplex telecommunication system. At such a system, receiving data inhibits the transmission of data. Half-duplex is the opposite of _Full_duplex.

Hub

A network component connecting multiple communication partners with each other. A hub does not provide own intelligence, thus it does not analyze the data traffic and sends received data to all connected communication partners. A hub can be used for setting up a star topology.

Industrial Ethernet

See Real-Time Ethernet

IP

Internet Protocol.

IP belongs to the TCP/IP family of protocols and is defined in RFC791. It is based on layer 3 of the ISO/OSI 7 layer model of networking.

It is a connectionless protocol, i.e. you do not need to open a connection to a computer before sending an IP data packet to it. Therefore IP is not able to guarantee that the IP data packets really arrive at the recipient. On IP level neither the correctness of data nor the consistence and completeness are checked.

IP defines special addressing mechanisms, see IP Address.

IP Address

Address within IP (the Internet Protocol, part of TCP/IP).

An IP address is an address identifying a device or a computer within a network using the IP protocol. IP addresses are defined as a 32 bit number. Usually, for ease of notation the IP address is divided into four 8 bit numbers which are represented in decimal notation and separated by points:

a.b.c.d

where a.b.c.d are each integer values between 0 and 255.

Example: 192.168.30.15

However, not all combinations are allowed, some are reserved for special purposes.

The IP address 0.0.0.0 is defined as invalid.

MAC-ID

MAC = Media Access Control

Definition for Ethernet:

A MAC-ID is on delivery a unique (physical) Ethernet address of the device.

MAC-IDs are defined as a 48 bit number. Usually, for ease of notation the IP address is divided into six 8 bit numbers which are represented in hexadecimal notation and separated by "minus"-signs (-):

A-B-C-D-E-F

where A-B-C-D-E-F are each integer values between 0 and 255.

Example: 00-02-A2-20-91-18

Definition for DeviceNet:

The network address of a device serves to distinguish itself on a DeviceNet fieldbus system from any other device or Slave on this network. This should be a unique number for each device. A valid MAC-ID address is within a range of 0 to 63 and can be re-entered and changed in the MAC-ID box in the Device Configuration Dialog.

Modbus Data Model

The data model distinguishes four basic types of data areas:

- Discrete Inputs (inputs) = FC 2 (Read)
- coils (outputs) = FC 1, 5, 15 (Write and Read back)
- Input register (input data) = FC 4 (Read)
- Holding register (output data) = FC 3, 6, 16, 23 (Write and Read back).

It should be noted, however, that depending on the device manufacturer and device type:

- the data area in the device may be present or not,
- and two data areas can be combined into one data region. For example, discrete inputs and input registers can be a common data area, which can be accessed with read-FC 2 and FC 4.
- Further FC 1 and FC 3 are used instead of reading back the inputs to read the outputs.

MPI

Multi Point Interface

The MPI is a proprietary interface of the SIMATIC® S7® series of PLCs. It is compatible to PROFIBUS and based on RS-485. It usually works with a transmission rate of 187.5 kBaud.

netX

networX on chip, Hilscher network communication controllers

netX Configuration Tool

The netX Configuration Tool allows users to operate cifX or netX based devices in different networks. Its graphical user interface serves as a configuration tool for the installation, configuration and diagnosis of the devices.

Object Dictionary

An object dictionary is a storage area for device parameter data structures. It is accessed in standardized manner.

Open Modbus/TCP

A communication system for Industrial Ethernet designed and developed by Schneider Automation and maintained by the Modbus-IDA organization based on the Modbus protocols for serial communication.

PCB

Printed Circuit Board, (printed = machine-made) circuit board

PCIe

Abbreviation for PCI Express

PC Card cifX

Communication Interfaces of the cifX product family of Hilscher on the basis of the communication controller netX 100:

for the Real-Time Ethernet systems

- EtherCAT
- EtherNet/IP
- Open-Modbus/TCP
- POWERLINK
- PROFINET IO
- sercos

and for the fieldbus systems

- PROFIBUS DP
- PROFIBUS MPI
- CANopen
- DeviceNet
- AS-Interface
- CompoNet

- VARAN
- CC-Link

as Communication Interface netX with PCI Bus

- PCI (CIFX50),
- PCI Express (CIFX 50E),
- Low Profile PCI Express (CIFX 70E, CIFX 100EH-RE\CUBE*),
- Compact PCI (CIFX80),
- Mini PCI (CIFX90),
- Mini PCI Express (CIFX 90E),
- PCI-104 (CIFX 104C)

and as Communication Interface netX with ISA Bus

- PC/104 (CIFX 104).

*only Real-Time Ethernet

PROFINET

A communication system for Industrial Ethernet designed and developed by PROFIBUS & PROFINET International (PI). It uses some mechanisms similar to those of the PROFIBUS field bus.

PROFINET IO Controller

A PROFINET control unit responsible for the defined run-up of an I/O subsystem and the cyclic or acyclic data exchange.

PROFINET IO Device

A PROFINET field device that cyclically receives output data from its IO-Controller and responds with its input data.

RE

RE stands for Real-Time Ethernet

Real-Time Ethernet

Real-Time Ethernet (Industrial Ethernet) is an extension of the Ethernet networking technology for industrial purposes with very good real-time features and performance. There is a variety of different Real-Time Ethernet systems on the market which are incompatible with each other. The most important systems of these are

- EtherCAT
- EtherNet/IP
- Ethernet POWERLINK
- Open Modbus/TCP
- PROFINET
- sercos
- VARAN

Register

A register is a 16-bit wide storage area for data which can be accessed and addressed as a unit by some of the Modbus Function Codes.

Depending on the used Modbus function code a single register or multiple registers sequentially located can be accessed.

Modbus differs Input Registers (FC 4) and Holding Registers (FC 3, 6, 16, 23).

Remanent

Remanent memory holds its data even after power-off, for instance flash memory is remanent. It is also called non-volatile memory.

RJ45

A connector type often used for Ethernet connection. It has been standardized by the Federal Communications Commission of the USA (FCC).

sercos

A communication system for industrial Ethernet designed and developed by Bosch-Rexroth and supported by sercos International.

Switch

A network component connecting multiple communication partners (or even entire branches of a network) with each other. A switch is an intelligent network component which analyzes network traffic in order to decide on its own. For the connected communication partners a switch behaves transparently.

SYNC

Synchronization cycle of the master

TCP/IP

Transport Control Protocol/Internet Protocol connection-orientated, secure transfer protocol as basis for the Internet-protocols

UCMM

Unconnected Message Manager

VARAN

Versatile **A**utomation **R**andom **A**ccess **N**etwork

A communication system for industrial Ethernet based on the DIAS-BUS developed by Sigmatek. The system is supported by the VARAN-BUS-NUTZERORGANISATION (VNO).

Watchdog Timer

A watchdog timer provides an internal supervision mechanism of a communication system. It supervises that an important event happens within a given timeframe (the watchdog time which can be adjusted accordingly, for instance by a parameter in the [Warmstart](#) message) and causes an alarm otherwise (usually this is accomplished by changing the operational state of the communication system to a more safe state).

XDD file

A special kind of Device Description file used by Ethernet POWERLINK.

XML

XML means Extended Markup Language. It is a symbolic language for structuring data systematically. XML is standard maintained by the W3C (World-wide web consortium). Device Description Files often use XML-based formats for storing the device-related data appropriately.

11.9 Contacts

Headquarters

Germany

Hilscher Gesellschaft für
Systemautomation mbH
Rheinstrasse 15
65795 Hattersheim
Phone: +49 (0) 6190 9907-0
Fax: +49 (0) 6190 9907-50
E-Mail: info@hilscher.com

Support

Phone: +49 (0) 6190 9907-99
E-Mail: de.support@hilscher.com

Subsidiaries

China

Hilscher Systemautomation (Shanghai) Co. Ltd.
200010 Shanghai
Phone: +86 (0) 21-6355-5161
E-Mail: info@hilscher.cn

Support

Phone: +86 (0) 21-6355-5161
E-Mail: cn.support@hilscher.com

France

Hilscher France S.a.r.l.
69500 Bron
Phone: +33 (0) 4 72 37 98 40
E-Mail: info@hilscher.fr

Support

Phone: +33 (0) 4 72 37 98 40
E-Mail: fr.support@hilscher.com

India

Hilscher India Pvt. Ltd.
New Delhi - 110 065
Phone: +91 11 26915430
E-Mail: info@hilscher.in

Italy

Hilscher Italia S.r.l.
20090 Vimodrone (MI)
Phone: +39 02 25007068
E-Mail: info@hilscher.it

Support

Phone: +39 02 25007068
E-Mail: it.support@hilscher.com

Japan

Hilscher Japan KK
Tokyo, 160-0022
Phone: +81 (0) 3-5362-0521
E-Mail: info@hilscher.jp

Support

Phone: +81 (0) 3-5362-0521
E-Mail: jp.support@hilscher.com

Korea

Hilscher Korea Inc.
Seongnam, Gyeonggi, 463-400
Phone: +82 (0) 31-789-3715
E-Mail: info@hilscher.kr

Switzerland

Hilscher Swiss GmbH
4500 Solothurn
Phone: +41 (0) 32 623 6633
E-Mail: info@hilscher.ch

Support

Phone: +49 (0) 6190 9907-99
E-Mail: ch.support@hilscher.com

USA

Hilscher North America, Inc.
Lisle, IL 60532
Phone: +1 630-505-5301
E-Mail: info@hilscher.us

Support

Phone: +1 630-505-5301
E-Mail: us.support@hilscher.com